



# Lambda Sensor

## 20 QUESTIONS & ANSWERS



# Lambda Sensor

## 20 QUESTIONS & ANSWERS



1. What is a Lambda sensor?	3
2. Why do cars need a Lambda sensor?	4
3. What does the Lambda sensor do?	5
4. Is there more than one type of Lambda sensor?	5
5. How does the Zirconia binary sensor work?	6
6. How is the Titania binary sensor different?	7
7. Why do sensors have different amounts of wires?	7
8. Why do sensors require a heater?	8
9. What is a wide band sensor?	8
10. Which cars use wide band sensors?	9
11. How does the wide band sensor work?	9
12. What is a diagnostic sensor?	10
13. How often should the sensor be renewed?	10
14. How can I identify which sensor is fitted to my car?	11
15. How does the NTK part number system work?	11
16. For fault diagnosis can a visual inspection tell me anything?	12
17. How can the sensor be tested?	13
18. Are there any installation tips?	13
19. Why should I choose NTK when replacing a sensor?	14
20. What does the future hold for sensors?	15



# 1

## What is a Lambda sensor?

**A LAMBDA SENSOR is a device fitted to cars, light commercials and even some motorcycles that are equipped with a petrol engine.**

It is located in the exhaust system and its purpose is to monitor the concentration of residual oxygen within the exhaust gases produced by the engine. A more descriptive name for this device is the exhaust gas oxygen sensor. Although oxygen sensors have many applications for industry, medicine and science the most common use is in the automotive sector.

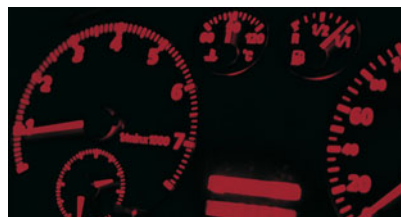



# 2 Why do cars need a Lambda sensor?

**WITH SO MANY vehicles in use on our roads the reduction of pollutants produced by the internal combustion engine is of ever increasing importance. To encourage advances in technology that can bring this about governments have progressively introduced tougher and tougher exhaust gas emission legislation.**

Lambda sensors are a vital part of the exhaust gas after treatment technology used by vehicle manufacturers to reduce engine emissions. This technology employs an oxygen sensor and three-way catalyst (catalytic converter) which together have the ability to take the three main toxic gases produced by an engine, carbon monoxide (CO), oxides of nitrogen (NO<sub>x</sub>) and hydrocarbons (HC) and convert them efficiently to considerably less harmful, non-poisonous gases: carbon dioxide (CO<sub>2</sub>), water (H<sub>2</sub>O) and nitrogen (N<sub>2</sub>).

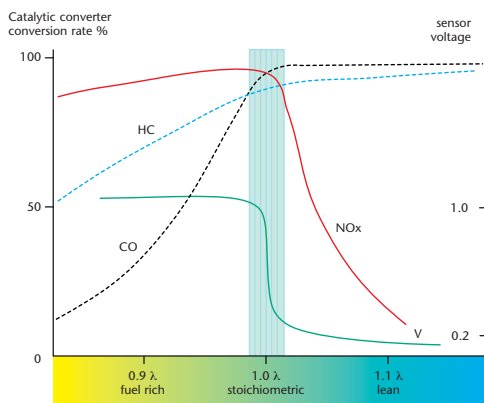

As a result of the function of the Lambda sensor the engine can also deliver the best economy and performance available.

From the end of 1992 most petrol engine cars and light commercial vehicles sold in the UK had Lambda sensors fitted. About 10 years later fitment to some types of motorcycles commenced.

## 3 What does the Lambda sensor do?

**IN ORDER for a catalyst to carry out the conversion of gases efficiently it must be provided with exhaust gases that are proportionally within certain very tight tolerances. To achieve this an engine needs to attain as close to complete combustion as possible – using up all the available fuel and oxygen.**

The ideal ratio of air to fuel to achieve complete combustion is 14.7:1; this means that for 14.7 kg of air 1 kg of fuel would be required. The term Lambda refers to the ratio of air to fuel; this chemically correct

air/fuel ratio is known as a stoichiometric ratio or Lambda ( $\lambda$ ) =1.0. A fuel rich mixture would have a lower value e.g. 0.8 and a fuel lean mixture would have a higher value e.g. 1.2.

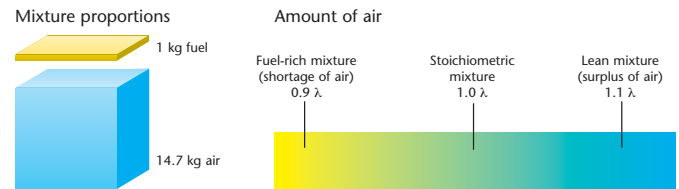

The precise control required to operate this system can only be provided by the use of a Lambda sensor which must be installed upstream of the catalyst. Depending on the oxygen content detected by the Lambda sensor, a signal is sent to the engine control unit which can then initiate a change to keep the fuelling system operating within the desired parameters. This is known as a closed-loop control system.

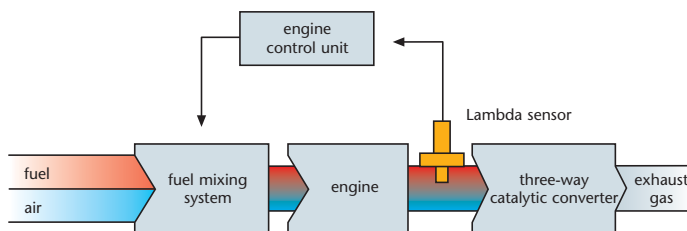

## 4 Is there more than one type of Lambda sensor?

**LAMBDA SENSORS have been continually developed since their initial fitment in the 1980's, this has lead to improvements in sensor performance and general durability. Over this period NTK have developed three sensor operating strategies for automotive application.**

The most common is the Zirconia binary sensor. This sensor generates a small voltage that varies in relation to the oxygen concentration. It is designated a binary type as its output can be interpreted as binary code.

The second type is the Titania binary sensor; this does not generate a voltage but it has the ability to modulate an applied voltage in relation to the oxygen concentration. Its output signal has a similar characteristic to the Zirconia type.

The third type is the wide band or air/fuel sensor. This sensor is considerably more sophisticated than the binary sensors. Faster and more accurate information regarding oxygen concentration can be obtained from this type. This sensor can also be termed a current generating sensor.

Each sensor type has its own specific operating system and therefore cannot be interchanged.



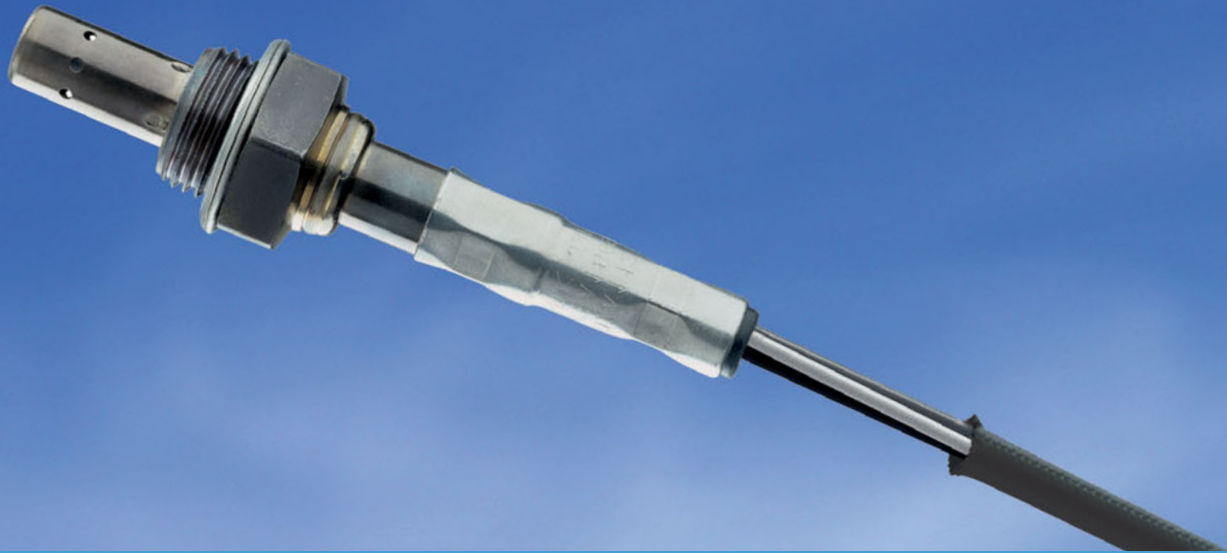

# 5

## How does the Zirconia binary sensor work?

**INSIDE the sensor there is a hollow thimble shaped ceramic body made from zirconium dioxide. The protective metal shell has specially designed holes to allow the exhaust gases to come into contact with the outside of the ceramic element. Both sides of this ceramic element are coated with a thin micro porous layer of platinum.**

These layers are the electrodes that carry the sensors signal to the wire cables. Over the outside electrode a thin additional layer of porous ceramic is added to protect the platinum from erosion by the exhaust gases. The inside of the thimble is hollow and is used to hold ambient air as a reference gas.

At temperatures in excess of 300°C the Zirconia element possesses a property that causes a transfer of oxygen ions. This movement creates a voltage. The greater the difference

of oxygen concentration between the exhaust gas and the ambient reference air in the centre of sensor thimble, the higher the voltage produced. The voltage produced in the fuel lean position should be approximately 0.1 volt and in the fuel rich position approximately 0.9 volt. The very useful part of this function is that at around the stoichiometric point there is a large easily readable change in voltage. This allows the sensor to keep the engine emissions within strict limits by constantly bringing the fuelling system back from a fuel lean or fuel rich position to retain the stoichiometric mixture. The time taken to switch from fuel lean to fuel rich is approximately 300 milliseconds.

Lambda sensor output signal

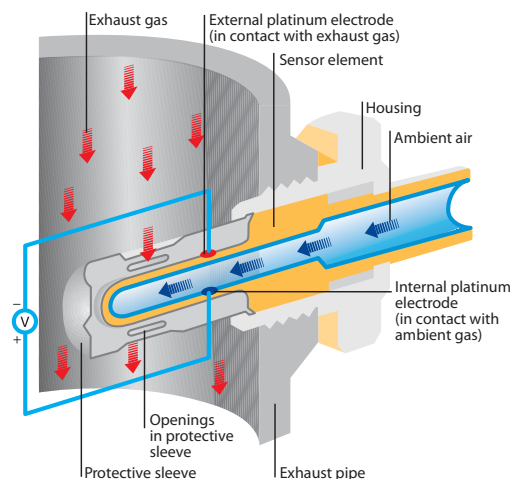
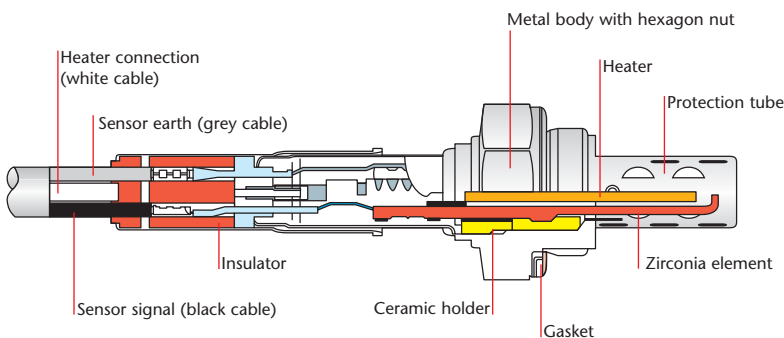
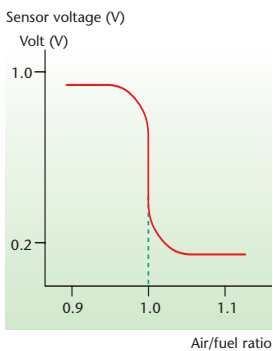

# 6 How is the Titania binary sensor different?

**EXTERNALLY these sensors can look similar to the Zirconia type however the sensor body may be generally smaller. These sensors do not generate a voltage as in the Zirconia type but the electrical resistance of the Titania changes in relation to the oxygen content of the exhaust gas.**

If there is a surplus of oxygen in the exhaust gas the element resistance rises and as the concentration of oxygen decreases (becoming fuel

rich) the resistance falls. As the stoichiometric point is passed, the Titania sensor element has a very large change in internal resistance. This results in an output signal characteristic similar to the Zirconia binary types. By virtue of its design there is no need for a pocket of air as a reference gas and due to certain other design differences the sensor can be smaller, stronger and have a faster reaction time. The control system for this type of sensor is very different to that used for the Zirconia type.

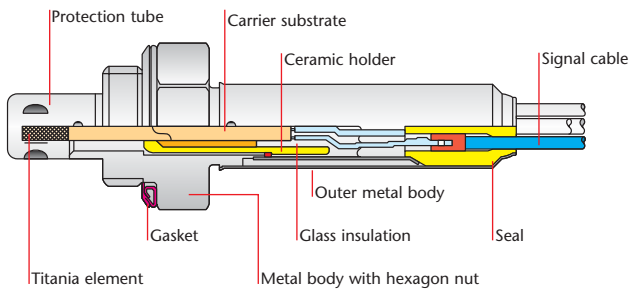

How the Titania sensor works

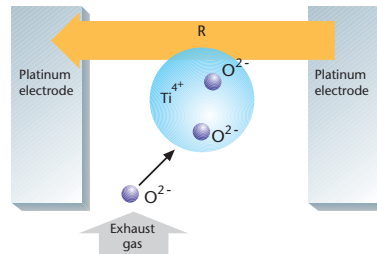

# 7 Why do sensors have different amounts of wires?

**EARLY SENSOR designs depended on the body of the sensor and the exhaust system of the car to provide the electrical ground and therefore had only one lead - the signal wire.**

The two wire sensor provided a more reliable ground, by the addition of a separate lead being connected directly to the vehicle wiring harness or ECU rather than relying on the exhaust system which is prone to corrosion and the possibility of poor ground continuity.

Sensors with an integral heater required additional lead wires for the heating element. Three wire sensors are usually the early types having two wires for the heater, one for signal with the ground being provided by the sensor's metal body via the exhaust system. Most Zirconia binary sensors now have four wires, a signal wire, a separate ground wire connected to the vehicle harness and a pair for the heater.

NTK's wide band sensors have five wires, two heater wires and three more connecting the sensor element to the integrated circuit built into the ECU.

### Zirconia Binary

<b>1 x wire</b> Black = signal	<b>3 x wire</b> Black = signal White = heater White = heater
<b>2 x wire</b> Black = signal Grey = ground	<b>4 x wire</b> Black = signal Grey = ground White = heater White = heater

### Titania

<b>Type 1</b>	Red = heater (+) White = heater (-) Yellow = signal (+) (OMITTED IN 3 x WIRE TYPES) Black = signal (-)
<b>Type 2</b>	Grey = heater (+) White = heater (-) Yellow = signal (+) Black = signal (-)

# 8

## Why do sensors require a heater?



**THE SENSOR needs to reach approximately 300°C before it starts to work and the exhaust gas can usually provide this heat energy. Under cold starting conditions however there is insufficient heat energy available in the gas and there is a delay before the fuelling system can be controlled as strictly as we would like. This could mean an increase in unwanted emissions.**

To combat this delay, heated exhaust gas oxygen (HEGO) sensors are used. These sensors have a heating device installed within the ceramic element, which rapidly brings the sensor up to temperature, and therefore strict fuelling control can start very quickly. During extended periods of idling, exhaust gas temperature can drop significantly; heated sensors ensure that this drop in temperature does not affect the stable operation of the sensor.

# 9

## What is a wide band sensor?

**SOME YEARS AGO NTK designed a sensor that could easily detect air fuel ratios well away from the stoichiometric point. Typical measurement can range from 8:1 in the rich region to beyond 30:1 in lean condition.**

There is little need to measure beyond this point as contemporary engine design will not allow the use of an air/fuel ratio leaner than 25:1, this is referred to as the "lean limit". Practical identification of these NTK sensors is by the five wires they need in order to communicate with the fuelling management ECU.

These sensors are also known as Air/Fuel or linear sensors.

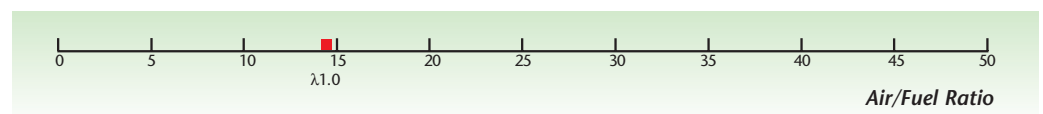

UEGO wide band Lambda sensor



# 10

## Which cars use wide band sensors?

**MOST ENGINES and catalysts are designed to operate efficiently when running with an air/fuel ratio of 14.7:1 or a stoichiometric mixture.**

Zirconia and Titania binary sensors can detect the change in the exhaust gas oxygen content at this point. One fairly obvious strategy to improve fuel consumption would be to use less fuel for the same given amount of air and some cars currently use this strategy under certain driving conditions. When in a cruising condition with light throttle loads the air/fuel ratio can be shifted to around 20:1. In order to monitor and therefore control fuelling in this area, a wide band type sensor is required.

Other applications that may require this type of sensor include: Motor racing, where extremely fast and precise measurement (sometimes in the rich segment) is essential.

Diesel or CNG (compressed natural gas) engines run with an excess air factor and therefore require a sensor that can read lean air/fuel ratios.



# 11

## How does the wide band sensor work?

**THESE SENSORS are manufactured using NTK's thick film technology producing a wafer like structure Zirconia element comprising a heater, an oxygen pumping cell and another cell which is used as an oxygen rich accumulator element.**

The operating principle is complex but similar to the more familiar Lambda 1.0 sensor involving the movement of oxygen ions across a ceramic substrate. By measurement of the current produced by the pump element the air/fuel ratio can be determined.

Each sensor requires its own ASIC (application specific integrated circuit) or "chip", similar to the drivers required for a computer peripheral. This ASIC is usually installed onto the circuit board of the engine management control unit. In addition, every sensor is individually trimmed during manufacture to produce an extremely accurate output by use of a selective resistor installed into the connector plug.

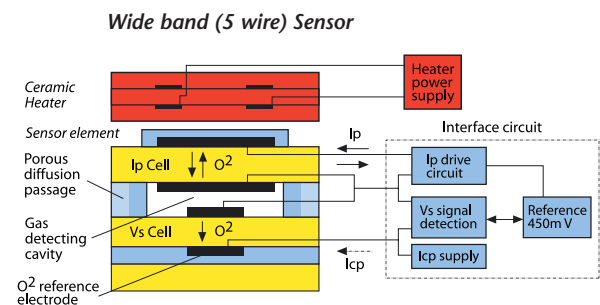

# 12

## What is a diagnostic sensor?

**With a sensor fitted upstream of the catalyst we have good control of the fuelling system providing the best possible combination of exhaust gases for efficient conversion thereby reducing harmful emissions to the legislated limits.**

This makes one big assumption – that the catalytic converter is functioning correctly. If the catalyst becomes faulty or ageing reduces its efficiency there will be an increase in toxic emissions and unless a gas analysis is carried out during service or repair the driver will be unaware.

By installation of another oxygen sensor downstream of the catalyst we can monitor the performance of the conversion process. If the output

from the catalyst is outside the manufacturers' predetermined tolerance the oxygen sensor can flag up a warning to the driver of the vehicle and a fault code can be held in the electronic control unit for diagnostic purposes.

These sensors are a vital part of the EOBD (European On Board Diagnostics) systems that help to keep cars performing efficiently and pollution to a minimum.

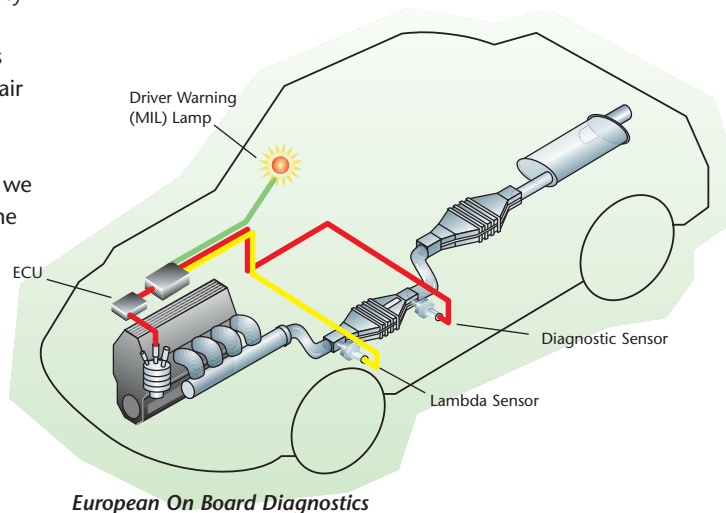

# 13

## How often should the sensor be renewed?

**LAMBDA SENSORS are designed to operate in an extremely hostile environment with extremes of temperature and in contact with corrosive exhaust gases.**

Lambda sensors have high life expectancy but the element will eventually age and the operation will become impaired which may increase fuel consumption, exhaust emissions and affect general engine performance.

Contamination by fuel and lubricant impurities such as silicones will also have a detrimental effect as can excess vibration or impact by road debris.

The use of leaded fuels, which are still available in some markets, may require the use of specifically protected sensors.

Sensor function should therefore be checked every 20,000 miles or annually. A visual inspection is recommended whenever the exhaust system is repaired and a full functional check carried out if any part adjacent to the sensor is involved.

If the catalyst is being replaced it is recommended that the sensor be renewed at the same time.



# 14

## How can I identify which sensor is fitted to my car?

**SIMPLY** take a look at the **NGK/NTK Lambda Sensor catalogue**, where our full list of **vehicle applications** is available.

This information is also featured on our website.  
Go to [www.ngkntk.co.uk](http://www.ngkntk.co.uk) and select Part Finder.



# 15

## How does the NTK part number system work?

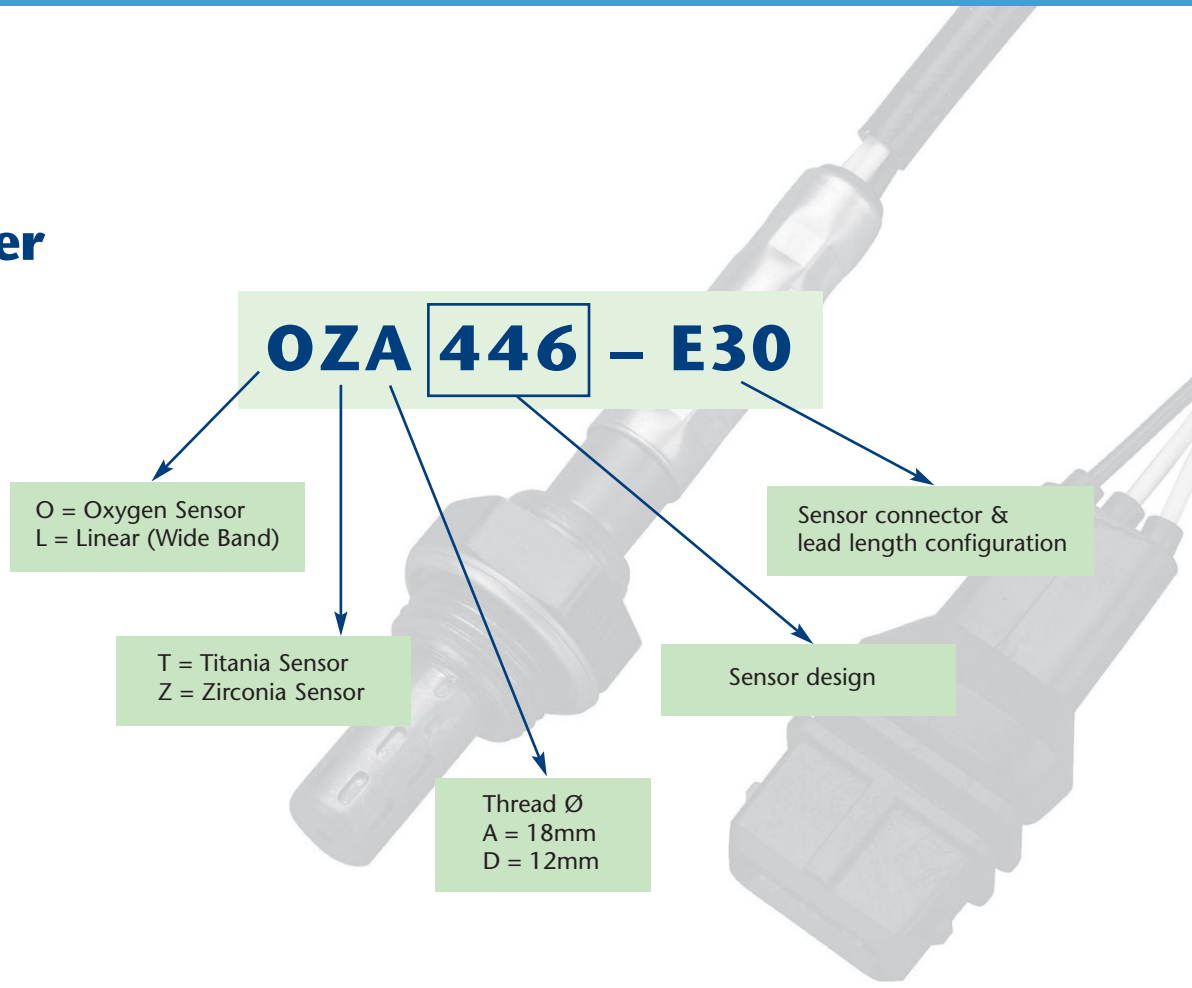

# 16

**For fault diagnosis can a visual inspection tell me anything?**

**A SIMPLE visual check of the sensor could save a lot of diagnostic time.**

The following images show some typical problems that affect sensor performance. In all cases it is imperative that the root cause is rectified to prevent premature failure of a replacement sensor.

**Problem**

Cables and plugs melted by contact with exhaust



**Solution**

Replace with new sensor and route without touching the exhaust

Frayed or broken cables

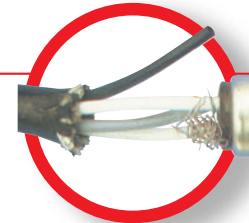

Replace with new sensor and make sure there is some slack in the cable

Cable seal is loosened  
Water may enter the sensor

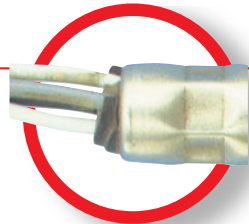

Replace with new sensor and make sure there is some slack in the cable

Sensor is bent

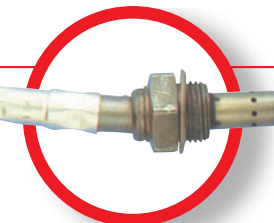

Replace with new sensor

Water in the connector

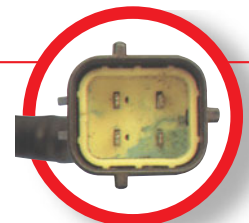

Replace with new sensor. Check electrical connections and seal off connector, and also the connection between the sensor and the engine control unit

Soot deposits are blocking the openings of the protective sleeve, due for example to fuel-rich mixture or high oil consumption because of wear on engine or valves and leaks in the exhaust system

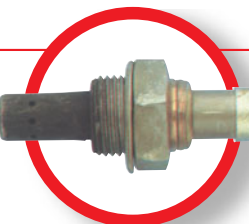

Diagnose and correct fault. Note: Excessive deposits of soot and oil on the protective sleeve are not caused by the sensor itself



# 17

## How can the sensor be tested?

**THE IDEAL WAY to test a sensor would be by using a combination of diagnostic tools including an oscilloscope, an exhaust gas analyser and an Ohmmeter.**

The oscilloscope will check the signal output from the sensor for amplitude and frequency. The frequency is the speed of response of the sensor to changes in fuelling. The gas analyser can check that if the fuelling is enriched or leaned off, the sensor will attempt to trim the injection back to its correct setting. The Ohmmeter can be used to check the heater circuit and the integrity of the earth circuit. Proprietary sensor testing tools are useful but some may be limited in their diagnostic ability. The use of a voltmeter to analyse sensor output is extremely limited in its ability and not suitable for checking on the vehicle. To prevent damage to the vehicle's electronic components great care must be exercised when connecting any diagnostic

equipment. Scan tools will be able to detect fault codes related to sensors and associated wiring that are stored in the vehicle's diagnostic system memory.

Don't forget that in order to check the output signal the sensor needs to have reached its operating temperature and the engine must be running at a reasonable speed, for example 2000 rev/min to produce the characteristic switching signal pattern.

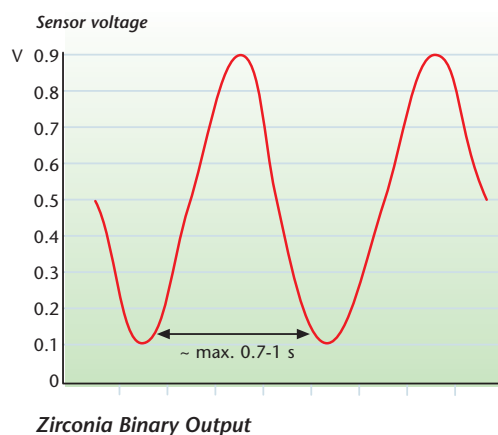

# 18

## Are there any installation tips?

**SENSORS are very vehicle specific, therefore it is essential that the replacement item has the same specification as the original factory fitted part.**

Differences in the wiring configuration may not be easily identified and therefore selection of the correct part is vital. Part of the EOBD (European On Board Diagnostics) function is to monitor the performance of both the fuel regulating and catalyst monitoring diagnostic sensor. Fitting a sensor that does not match the specification of the original part could result in poor running, record a fault code or cause the MIL (malfunction indicator lamp) to illuminate, telling the driver that there is a problem in the system.

Sensors live in a harsh environment and corrosion of the exhaust and

sensor is inevitable. This can make removal difficult and so it is essential that suitable tools be employed, such as a tube spanner, to prevent personal injury or damage to the sensor.

Before installing the new sensor, ensure that the threads are clean and in good condition. All NTK sensors have a factory applied anti-seize compound on the threads. This grease is sensor friendly and care should be taken if alternative greases are used to make sure that they contain no sensor damaging ingredients.

Tighten the sensor to the recommended torque to ensure correct sealing, a good earth via the exhaust (if applicable) and not to over stress the metal shell. Before connecting the multi-plug, check the vehicle side connector for damage, oil contamination and corrosion.



*Torque figures and thread form information:*

**M18 x 1.5mm  
- 35 ~ 45Nm**

**M12 x 1.5mm  
- 18 ~ 23Nm**

# 19

## Why should I choose NTK when replacing a sensor?



- ✔ **NTK Sensors always match or exceed Original Equipment specification**
- ✔ **NTK sensors have a factory fitted connector and all the necessary grommets, harness clips and protective sheath as supplied with the original part.**
- ✔ **Every sensor has a full functional test at the factory**
- ✔ **The connection at the vehicle harness can be a problem area, this connection is remade when using the NTK sensor**
- ✔ **Its not possible for water to ingress the sensor body or electrical connections**
- ✔ **Saves considerable time when compared to fitting universal types**
- ✔ **NTK sensors are always compatible with On Board Diagnostic Systems**
- ✔ **Have confidence in fitting sensors made by World's largest sensor manufacturer**

# 20

## What does the future hold for sensors?

**NTK is continually developing faster acting and more accurate sensors for cars. Ideas such as a sensor that is energised remotely as the driver approaches the vehicle could help reduce emissions even further.**

Cars are not the only source of engine pollution; any device that uses the internal combustion engine will create pollution. It has been established by independent research that one hour's use of a typical lawn mower creates as much pollution as driving a modern car for approximately 100 miles. Small engines are used on many horticultural and industrial applications such as lawn mowers, chainsaws and generators. NTK's innovative engineers are continually striving to develop lighter and more compact sensors with simple control systems that are suitable for use with smaller engines.

Other pollution control sensors manufactured by NTK include NOx detectors, exhaust gas temperature sensors, air quality sensors and hydrogen sensors. Whatever direction engine design takes, NTK's relentless research into the vital area of pollution reduction will continue to assist in providing cleaner air for the environment.

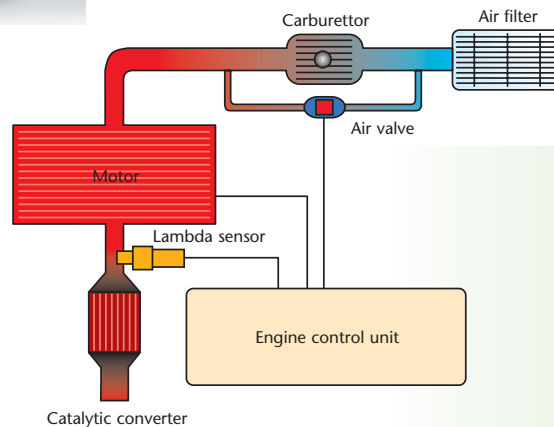

*Operation of a carburettor type petrol engine with a regulated catalytic converter*





NGK Spark Plugs (UK) Ltd.  
Maylands Avenue  
Hemel Hempstead  
Hertfordshire  
HP2 4SD England

Tel: 01442 281000  
Fax: 01442 281001

[www.ngkntk.co.uk](http://www.ngkntk.co.uk)

For up-to-date information  
about Lambda sensors go to:  
[www.ngkntk.co.uk](http://www.ngkntk.co.uk)

