



Installation manual



Instrumentation 2.0

Marine engines
DI09, DI13, DI16



344 457



INSTALLATION MANUAL

System overview	3	Password: dcu > Password.....	45
List of abbreviations.....	3	File management: dcu > File	46
System overview	3	Configuring input signals: dcu > I/O Configuration > Config Inputs	47
Positioning of the displays	5	Configure output signals: dcu > I/O Configuration / Config Outputs	63
Connection	7	Designing instrument pages: dcu > Interface Design	67
Electrical cables.....	7	Set the sequences for starting, stopping and for lubrication: dcu > Start/Stop/Pre-lube	69
Junction box, connection.....	8	Settings for the user interface: dcu > User Interface	72
Junction box, components	11	Changing the engine designation: dcu > Engine Model	73
Main display (DCU), junction blocks	12	Setting the maintenance interval: dcu > Service Interval	74
Auxiliary display (RP), junction blocks.....	19	Network settings: dcu > Communication	75
Safety module (SDU), connection	22	Other functions: dcu > Miscellaneous	77
Gateway – overview.....	22	SDU	82
Position of the monitors on the engine.....	23	Auxiliary display	83
Connecting emergency stop	25	First start	83
Engine shutdown override in systems with safety device unit (SDU).....	26	Administration in the auxiliary display	85
Using the main display	27	Examples of connection of sensors and monitors	92
First start.....	27	Connection of 4-20 mA, e.g. oil pressure sensor for the reverse gear.....	92
Navigation	30	Connection of PT100, e.g. coolant temperature sensor	94
Administration in the main display	33	Connection of switch input, e.g. low engine oil pressure monitor	96
Configuring and upgrading software with USB memory stick	37		
Configuring the main display with a USB memory stick	38		
Upgrading the main display or auxiliary display software	39		
Copying one configuration file in the main display	39		
Configuring the main display via a web browser	40		
Connecting a computer to the main display	40		
General information about the IP address	42		
Homepage.....	43		
Logging in to the main display.....	44		
Important system settings: dcu / Miscellaneous / System Type.....	44		



System overview

List of abbreviations

The abbreviations in the list below are used in this manual. DCU, RP och SDU appear in the display interface and in the configuration interface.

Abbreviation	Description
DCU	Main display
RP	Auxiliary display
SDU	Safety device unit
FMI	Failure Mode Identifier
SPN	Suspect Parameter Number

System overview

The illustration shows an overview of component parts in a marine engine management system prepared for classification.

Main display (DCU)

The main display is the basic unit of the engine management system. Different sensor values are displayed on the main display touch screen, and different commands are also carried out there.

The main display is configured using a computer with a web browser via the built in web server of the main display. This is described in the [Configuring the main display via a web browser](#) section.

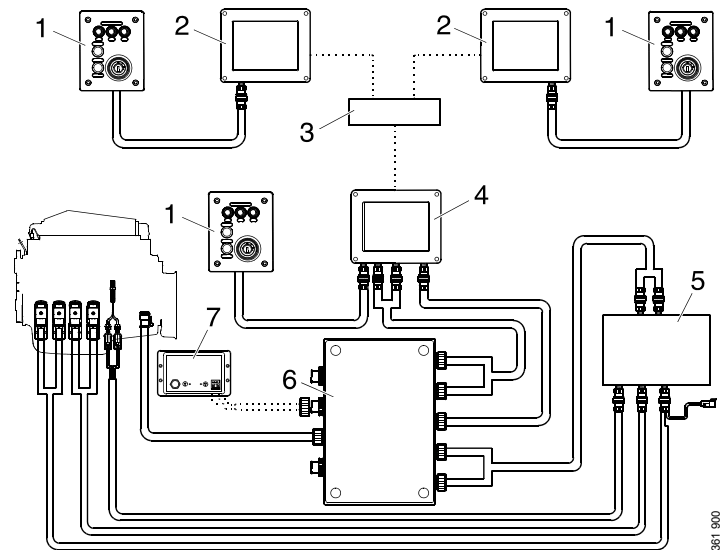

Example of the layout of a type approved marine engine management system.

1. Control panel.
2. Auxiliary display (RP).
3. Network switch.
4. Main display (DCU).
5. Safety module (SDU).
6. Junction box.
7. Gateway.



Auxiliary display (RP)

The auxiliary display is an option and has the same user interface as the main display. The auxiliary display reads the configuration from the main display. This makes it easy to retrofit.

Control panel

The engine can be started and stopped through the control panel. It can also be used to activate and adjust engine speed settings 1 or 2. The engine installation can be carried out with or without a control panel.

Network switch

A network switch is only required if more than one auxiliary display is connected to the engine management system. If the system only contains one auxiliary display, it is connected directly to the main display via a crossover network cable.

Safety module (SDU)

The safety device unit has monitoring and shutdown functions and is a requirement for classified engine management systems. It should be easily accessible so that alarms can be acknowledged in an easy way.

Junction box

The junction box is used to connect all the parts of the engine management system to the engine. The junction box also contains fuses. It should be easily accessible.

Gateway

The gateway reads specific messages about position and speed via NMEA 2000, so that the instrumentation can calculate fuel consumption per nautical mile. The gateway cannot process messages other than these. The gateway requires software version 2.11 or later to be installed in the displays.

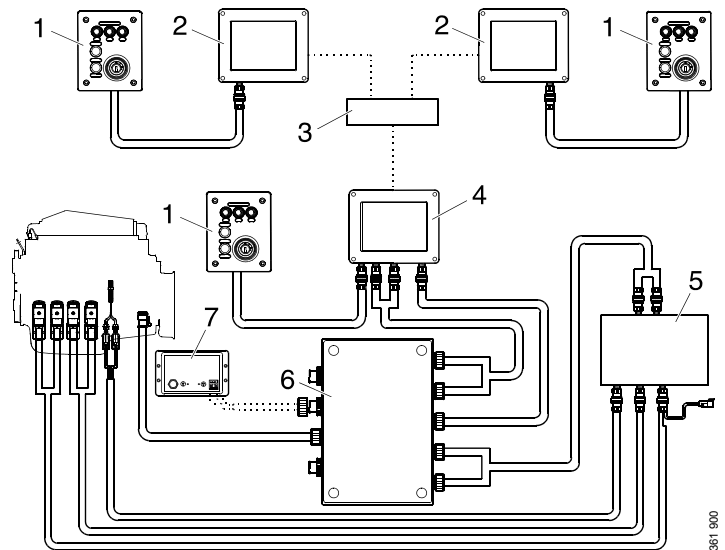

Example of the layout of a type approved marine engine management system.

1. Control panel.
2. Auxiliary display (RP).
3. Network switch.
4. Main display (DCU).
5. Safety module (SDU).
6. Junction box.
7. Gateway.



Positioning of the displays

Do not position the displays so that they are exposed to direct sunlight. This impairs the readability of the displays. The user should have full access to the displays. It must also be easy to access the connections on the rear of the displays.



IMPORTANT!

The displays must not be fitted on vibrating equipment. They may only be positioned next to the engine bed if either the engine or the display housing has vibration damping.

Installation dimensions

Provide a 150 x 120 mm rectangle where the display is to be positioned. There must be at least 70 mm free space behind the display.

Main display

Scania recommends positioning the main display in the engine compartment for the following reasons:

- To ensure that operation and monitoring are close to the engine.
- To minimise the lengths of the electrical cables between the sensors and main display.
- To reduce the risk of electrical interference caused by long electrical cables.



REQUIREMENT!

On a type approved installation, the main display must be located in the engine compartment.

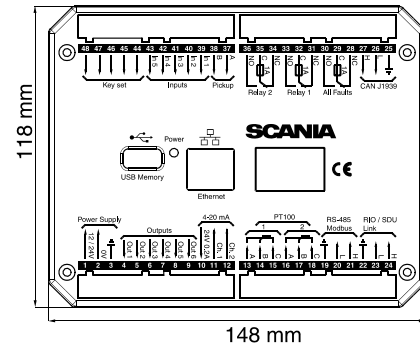

Installation dimensions for the main display and auxiliary display.

361 901



Auxiliary display

The auxiliary display is normally positioned outside the engine compartment, but can also be positioned in the engine compartment.



Connection

Electrical cables

To protect against electromagnetic interference, Scania recommends that all electrical cables within the system are twisted in pairs with 35-40 turns/m. This only applies to external signal cables connected to the system.

IMPORTANT!

If a shielded electrical cable is used, the shielding should be connected to ground, not to 0 V. Only connect the shielding to one end of the electrical cable.

To provide good separation of the electromagnetic interference that can occur, some of the electrical cables can be routed separately from the others, e.g. the signal cable from a magnetic pulse sensor.

Electrical cables for electric power supply must have a minimum cross section of 2.5 mm².

Ground

IMPORTANT!

Separate ground and 0 V. In marine installations, ground and 0 V must not be connected. The hull is ground and the battery negative terminal is 0 V.

24 V and 0 V are filtered in the main display in order to reduce electromagnetic interference. If ground and 0 V are connected together, the filters in the main display will not function.



Junction box, connection

Minimum connection

The minimum connection required for the system to function is for the pins on connector C4066 to be connected. If the throttle control is to be controlled via the main display, then pins 1 and 2 of connector C4068 must also be connected.

Please refer to the electrical system installation manual 03:01 for information on how to connect the throttle control to the engine control unit. If the throttle control is connected to the engine control unit, secondary throttle control cannot be used.

C4066

Connection of power supply to the engine management system and instrumentation 2.0 (battery).

Pin	Description	I/O
1	30 voltage, 24 V	-
2	Ground (battery negative terminal)	-
3	30 voltage, 24 V	-
4	Ground (extra battery negative terminal)	-

Note:

If the system has a safety device unit (SDU), 2 separate groups of batteries must be used.

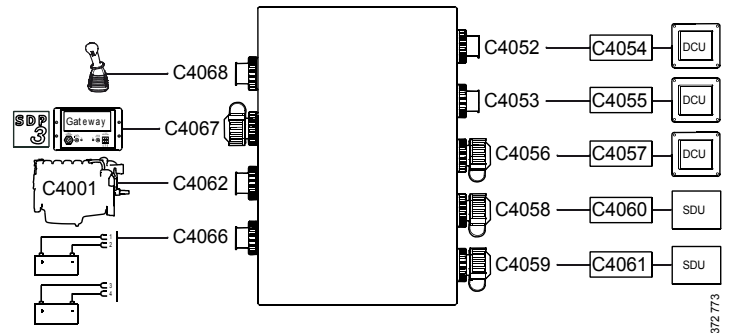

Connecting the junction box.

372 773



INSTALLATION MANUAL

Connection

C4062

Connection to engine connector C4001.

C4067

Diagnostic socket for connecting e.g. SDP3 and CAN communication. Use connector 1 508 055 and hand crimping tool 99 494.



REQUIREMENT!

Any equipment connected to the connector must comply with the CAN specification.

Pin	Description	I/O
1	15 voltage: 24 V after fuse F4005 and relay in the junction box. Controlled by the system being active.	-
2	Ground	-
3	CAN high	-
4	CAN low	-

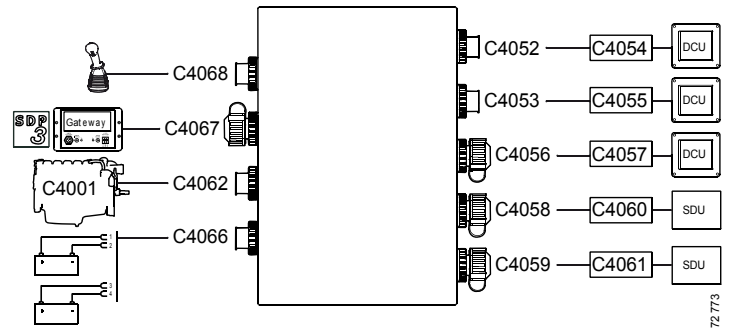

Connecting the junction box.

372 773



C4068

Connecting the incoming throttle actuation signal. The update frequency is 100 Hz, with a median filter on 3 readings.

Pin	Description	I/O
1	24 V (0.2 A), voltage supply to passive throttle control	O
2	Input for signal from throttle control, 4-20 mA	I
3	Not used	-
4	Not used	-

C4052

Connection to main display via C4054.

C4053

Connection to main display via C4055.

C4056

Connection to main display via C4057.

C4058

Connection to safety device unit (SDU) via C4060.

C4059

Connection to safety device unit (SDU) via C4061.

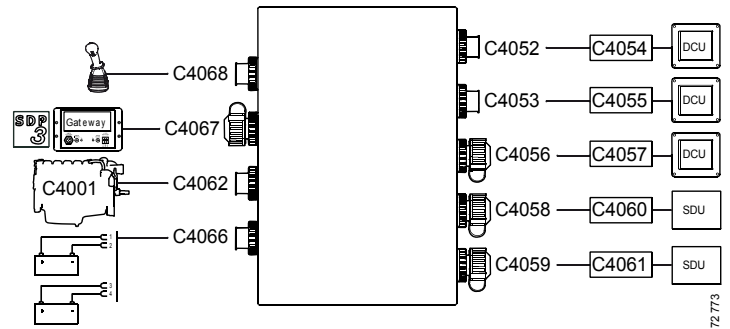

Connecting the junction box.

372 773



Junction box, components

There are two 20 A miniature circuit breakers in the junction box, one for each battery connection. Depending on the cable length, it may be necessary to fit extra fuses for the electrical cable. The junction box also has a number of blade fuses, diodes and relays as described below.

	Designation	Description
1	F4010	20 A miniature circuit breaker for incoming voltage from battery group, main supply
2	F4011	20 A miniature circuit breaker for incoming voltage from battery group, redundant supply
3	R4005	Relay for 15 voltage
4	F4013	2 x 2 A blade fuses for auxiliary socket
5	D4017	Diode to separate the battery groups, ground
6	D4018	Diode to request shutdown/activation of 15 voltage
7	R4004	Relay for engine shutdown (15 voltage)
8	R4003	Relay for engine shutdown (30 voltage)
9	R4002	Relay for detecting loss of redundant battery group
10	R4001	Relay for detecting loss of main battery group
11	D4016	Diode to separate the battery groups (30 voltage)
12	F4012	2 x 20 A blade fuses for engine control unit, 2 x 5 A blade fuses for internal supply to panels

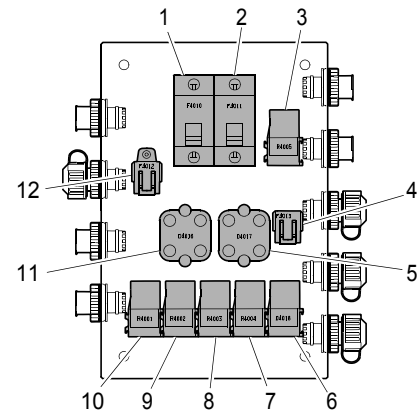

Components in the junction box.

347 887



Main display (DCU), junction blocks

The only connection needed for the system to work is for the main display connector to be connected and the main display to be connected to the junction box via junction box connectors C4052, C4053 and C4056. See [System overview](#).

The connections on the main display are listed on the following pages.

Electric power supply: junction block 1-3

	Description	I/O
1	24 V main power supply	I
2	0 V main power supply	I
3	Ground connection	I

The system is designed for a voltage of 24 V.

REQUIREMENT!

Connect the display directly to the battery and not to the starter motor. Use twisted pair electrical cables and do not make the electrical cable longer than necessary. The cable cross-sectional area must be at least 2.5 mm².

Alarm at low voltage

Warning < 21 V
Alarm < 18 V

There is a 30 second delay before the alarm or warning is activated.

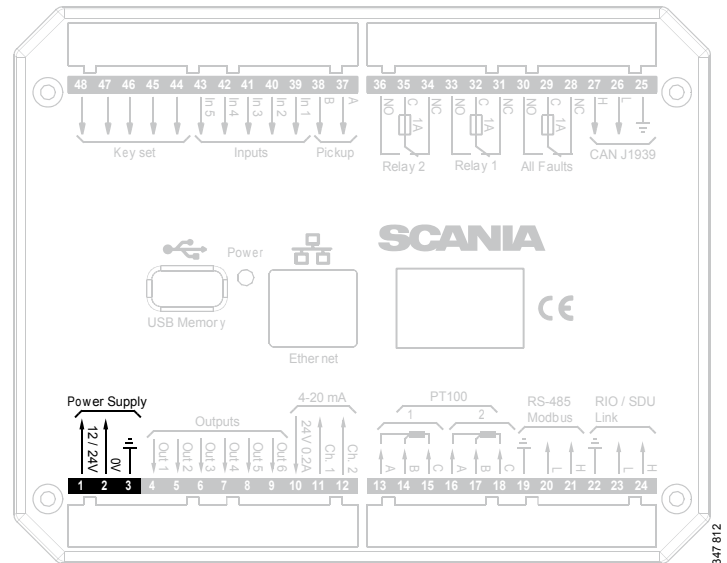

Junction blocks on the main display.



Change-over output: junction block 4-9

The main display has six 24 V outputs that can be configured individually for optional functions or events. See the [12/24V Output Functions](#) section.

	Description	I/O
4	24 V output #1 (0.5 A shared with output #2)	O
5	24 V output #2 (0.5 A shared with output #1)	O
6	24 V output #3 (0.2 A)	O
7	24 V output #4 (0.2 A)	O
8	24 V output #5 (0.2 A)	O
9	24 V output #6 (0.2 A)	O

4-20 mA input: junction block 10-12

The main display has two configurable analogue inputs. Information on how to configure the inputs is in the [4-20 mA](#) section.

	Description	I/O
10	24 V supply (0.2 A). The junction block is occupied	O
11	4-20 mA input #1	I
12	4-20 mA input #2	I

If the signal is outside the following limit values, a warning is displayed on the display.

- Less than 2 mA: defective
- Over 24 mA: short circuit

2-4 mA is treated as 4 mA and 20-22 mA is treated as 20 mA. The updating frequency is 2 Hz.

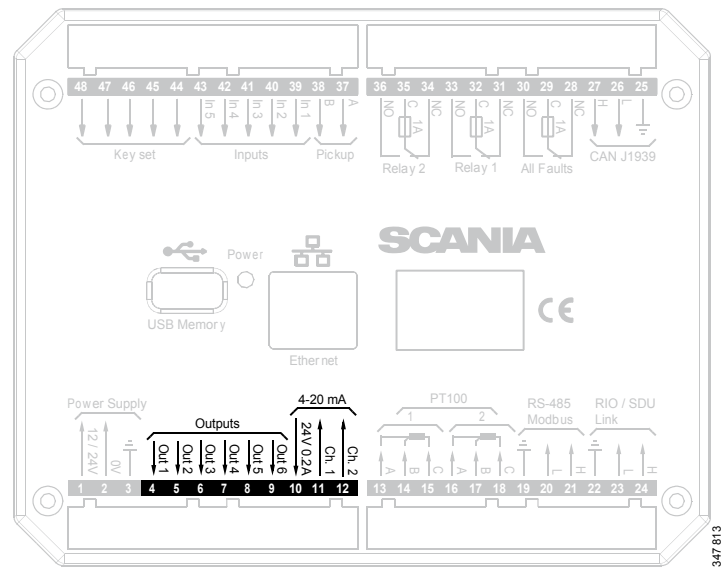

Junction blocks on the main display.



INSTALLATION MANUAL

Connection

PT100 input: junction block 13-18

There are two PT100 inputs in the main display. The inputs are adapted for PT100 sensors with 2 or 3 electrical cables. Connect the electrical cables as follows:

2 wire PT100: Bridge A and B. Connect one wire to AB and the other to C.

3 wire PT100: Connect A to A, B to B and C to C.

4 wire PT100: Connect in the same way as 3 wire PT100, but note that the fourth wire, D, should not be connected. It should hang loose or, if necessary, be cut off.

Information on how to configure the inputs is in the [PT100](#) section.

	Description	I/O
13	PT100 #1 A	I
14	PT100 #1 B	I
15	PT100 #1 C	I
16	PT100 #2 A	I
17	PT100 #2 B	I
18	PT100 #2 C	I

If the signal is outside the following limit values, a warning is displayed on the display.

Below 90 ohms short circuit
Above 390 ohms defective

The updating frequency is 2 Hz.

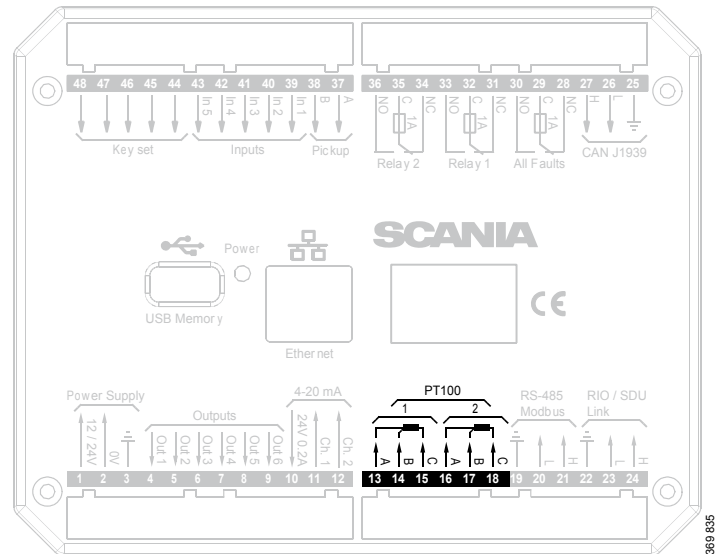

Junction blocks on the main display.



INSTALLATION MANUAL

Modbus RTU, RS-485: junction block 19-21

The main display has a built-in Modbus™ interface, on both RS-485 and Ethernet. The latter can also be designated Modbus TCP.

	Description	I/O
19	Shielded	I
20	Low	I
21	High	I

RIO link: junction block 22-24

Not used.

J1939 CAN interface: junction block 25-27

Connection to engine control unit via CAN. The connection is terminated.

	Description	I/O
25	Not used	I
26	Low	I
27	High	I

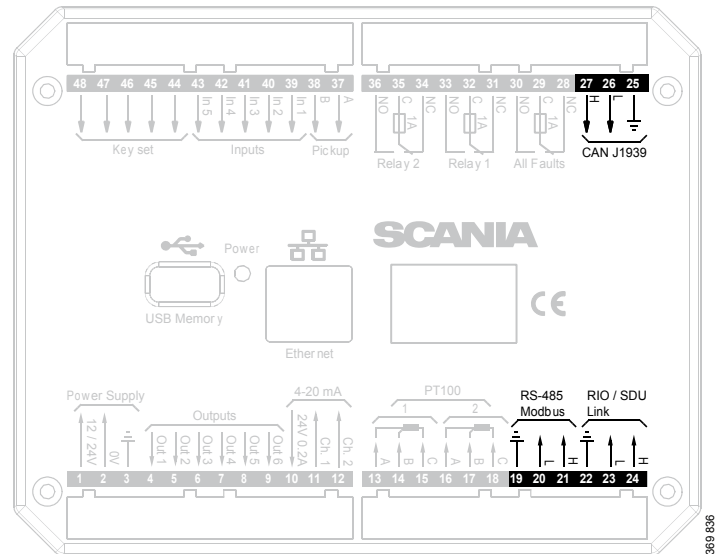

Junction blocks on the main display.



Relay for all faults: junction block 28-30

The relay is activated when there are no active faults and is deactivated when a fault occurs. Every new event is counted as a fault in the alarm list, except diagnostics messages with a white ranking. The relay can be used to switch on an external lamp or emit an acoustic signal, for example.

	Description	I/O
28	NC (1 A)	-
29	C (1 A)	-
30	NO (1 A)	-

Relay #1: junction block 31-33

The relay can be configured so that it is activated for any of the built in functions. See the [Relay Functions](#) section.

	Description	I/O
31	NC (1 A)	-
32	C (1 A)	-
33	NO (1 A)	-

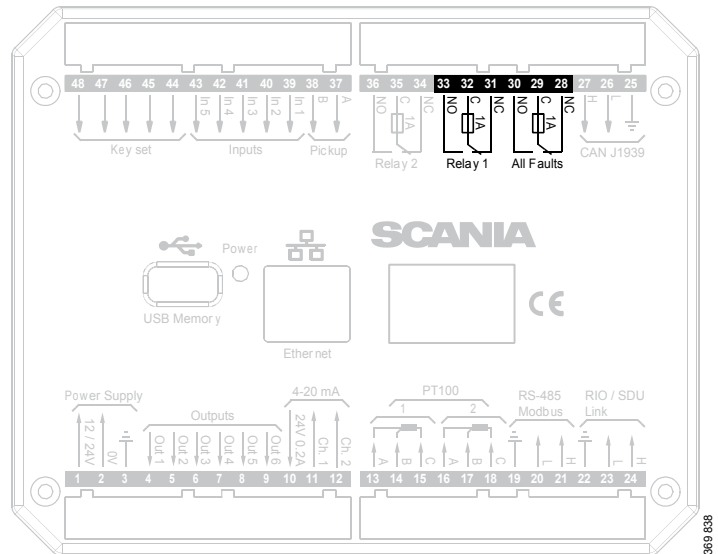

Junction blocks on the main display.



Relay #2: junction block 34-36

The relay can be configured so that it is activated for any of the built in functions. See the [Relay Functions](#) section.

	Description	I/O
34	NC (1 A)	-
35	C (1 A)	-
36	NO (1 A)	-

Input for magnetic pulse sensor: junction block 37-38

An auxiliary rotational speed sensor is connected here. Only shield the electrical cable on the sensor side. Information on configuration is in the [Local Pickup](#) section.

	Description	I/O
37	A	I
38	B	I

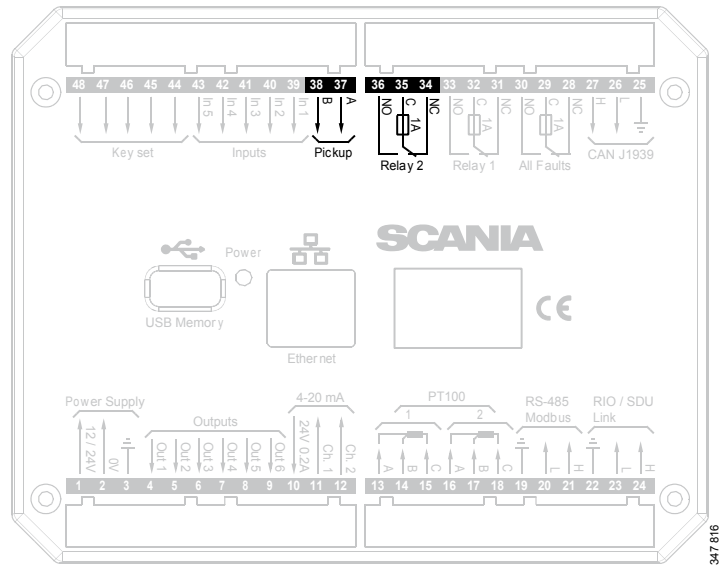

Junction blocks on the main display.



Change-over input: junction block 39-43

There are five 24 V inputs that can be configured individually for available functions. For example, a low oil pressure sensor can be connected, or the input can be configured to activate a built in function such as automatic start.

If there is a safety device unit (SDU) in the system, three of the inputs are reserved. Information on how to configure the inputs is in the [Switch](#) section.

	Description	I/O
39-41	24 V inputs. The inputs are reserved if there is a safety device unit in the system.	I
42-43	24 V inputs, configurable.	I

Connection of control panel. junction block 44-48

If there is no control panel in the system, inputs 44-48 can also be configured. However, this only applies if the software version of the display is 2.12 or later. Information on how to configure the inputs is in the [Switch](#) section.

	Description	I/O
44-48	24 V inputs. Reserved in systems with control panel.	I

Ethernet (Modbus TCP)

The main display is connected to the LAN or directly to a computer via a standard CAT-5 network. Connect to port RJ45 via a crossover network cable. The IP address in the main display or the computer may need to be changed in order to configure the main display via a web browser.

USB input

See the [Configuring and upgrading software with USB memory stick](#) section.

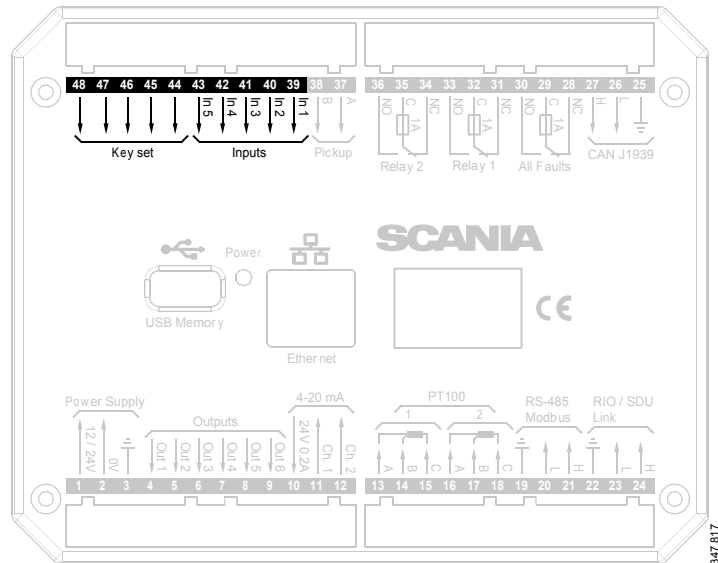

Junction blocks on the main display.



Auxiliary display (RP), junction blocks

Electric power supply: junction block 1-3

	Description	I/O
1	24 V main power supply	I
2	0 V main power supply	I
3	Ground connection	I

The auxiliary display must have a separate electric power supply. The system is designed for a voltage of 24 V.

REQUIREMENT!

Connect the display directly to the battery and not to the starter motor. Use twisted pair electrical cables and do not make the electrical cables longer than necessary. The cable cross-sectional area must be at least 2.5 mm².

Note:

Scania recommends connecting the auxiliary display to the same fuse group as the main display.

Alarm at low voltage

Warning < 21 V

Alarm < 18 V

There is a 30 second delay before an alarm or warning is activated.

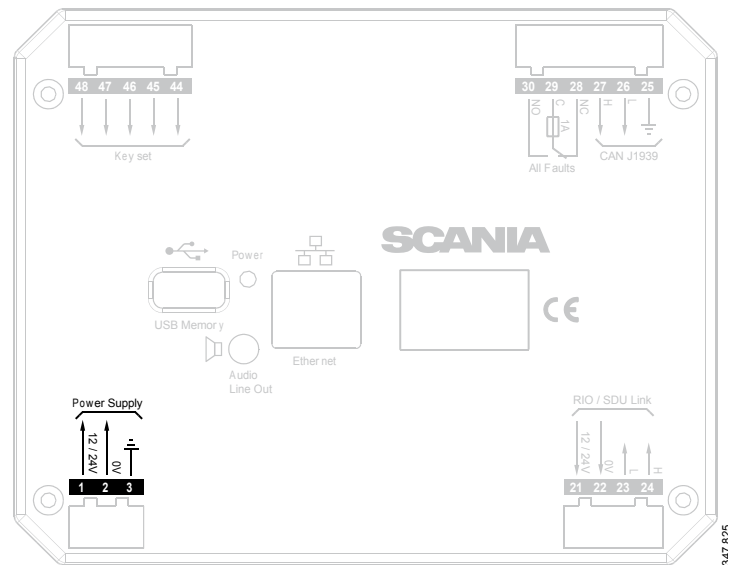

Junction blocks on the auxiliary display.



RIO link: junction block 21-24

Not used.

J1939 CAN interface: junction block 25-27

Not used. The connection is terminated.

Relay for all faults: junction block 28-30

The relay is activated when there are no active faults and is deactivated when a fault occurs. Every new event is counted as a fault in the alarm list, except diagnostics messages with a white ranking.

	Description	I/O
28	NC	-
29	C	-
30	NO	-

Connection of control panel. junction block 44-48

	Description	I/O
44	24 V input #6. Reserved for the control panel	I
45	24 V input #7. Reserved for the control panel	I
46	24 V input #8. Reserved for the control panel	I
47	24 V input #9. Reserved for the control panel	I
48	24 V input #10. Reserved for the control panel	I

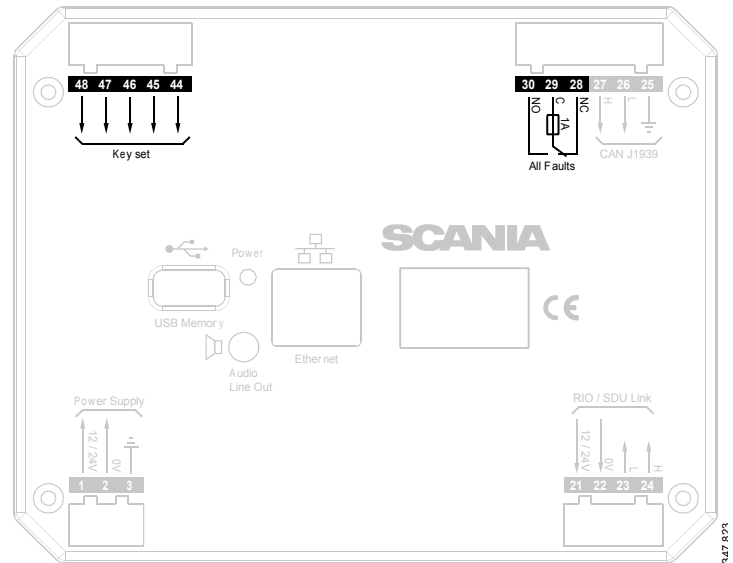

Junction blocks on the auxiliary display.



Ethernet (Modbus TCP)

Connection to the LAN.

USB input

See the [Configuring and upgrading software with USB memory stick](#) section.

Loudspeaker output

The auxiliary display has a standard output of 3.5 mm for the connection of regular computer speakers. The installation will then have more sounds than just the built in buzzer, and different types of sound can be linked with different events. This is how to activate external speakers:

- In the auxiliary display, go to *Menu > Settings > Sound*.
- Activate the *Speakers* option with the *Sound Configuration* button.

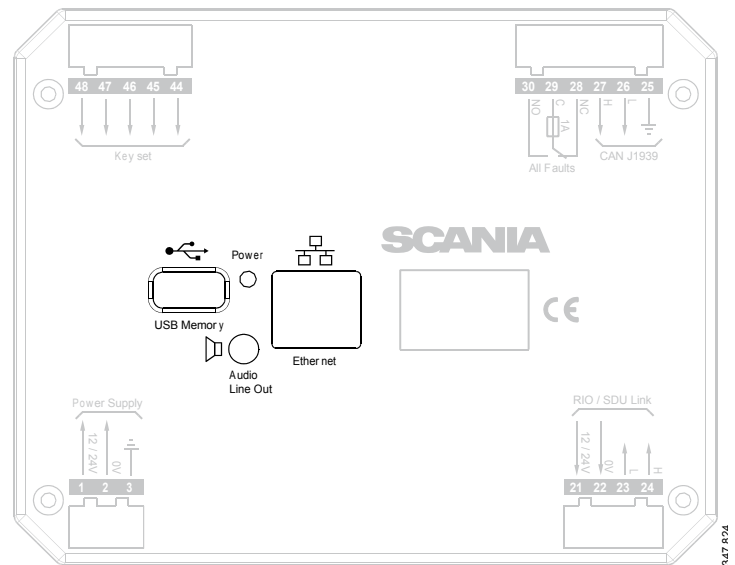

Junction blocks on the auxiliary display.



Safety module (SDU), connection

The illustration shows the safety device unit connections.

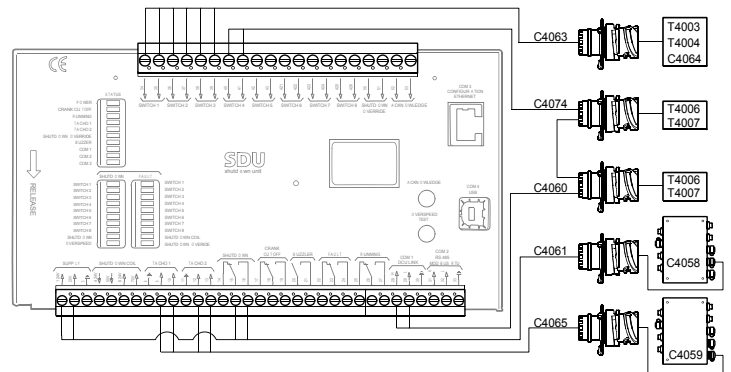

372 772

Gateway – overview

Pos.	Description
1	Connection to the ship NMEA 2000 network.
2	"NMEA Instance" rotary control. Set the instance which the gateway transmits to other units. Used if 2 or more gateways are connected to the same NMEA 2000 network. In such a case, make sure that each gateway has a unique instance, e.g. "0" and "1".
3	Blue "Tx" LED, indicates that data is being received from NMEA 2000 every 2.5 seconds.
4	Green "Rx" LED, indicates that data is being sent to J1939.
5	"J1939 Source" rotary control. Set the instance for the NMEA 2000 GPS which the information should be loaded from. If the gateway does not receive any signals from a GPS with the selected instance within 30 seconds, all valid GPS data is transferred automatically.
6	Connection to connector C4067 junction box. See C4067 .

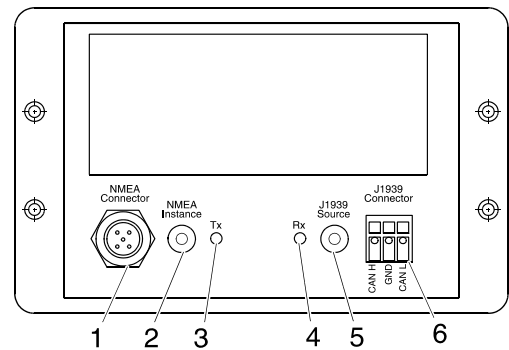

361 902



Position of the monitors on the engine

The illustration shows the position of the monitors on DI09 and DI13.

See *02:01 Engine* for information on where to connect external monitoring sensors.

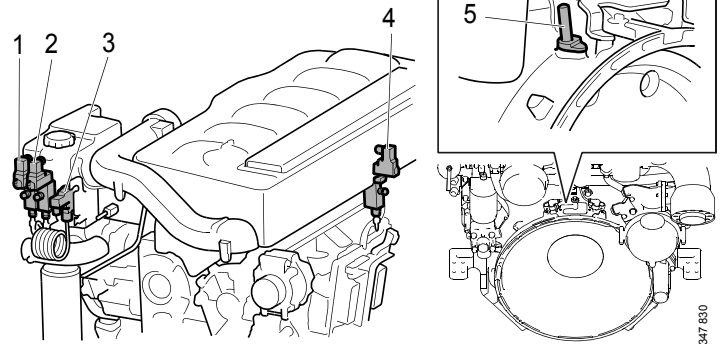

DI09, DI13.

1. Coolant pressure monitor, T4006.
2. Oil pressure monitor, T4003.
3. Coolant temperature monitor, T4004.
4. Fuel pressure monitor, T4007.
5. Engine speed monitor, T4005.



The illustration shows the location of the monitors on DI16.

See *02:01 Engine* for information on where to connect external monitoring sensors.

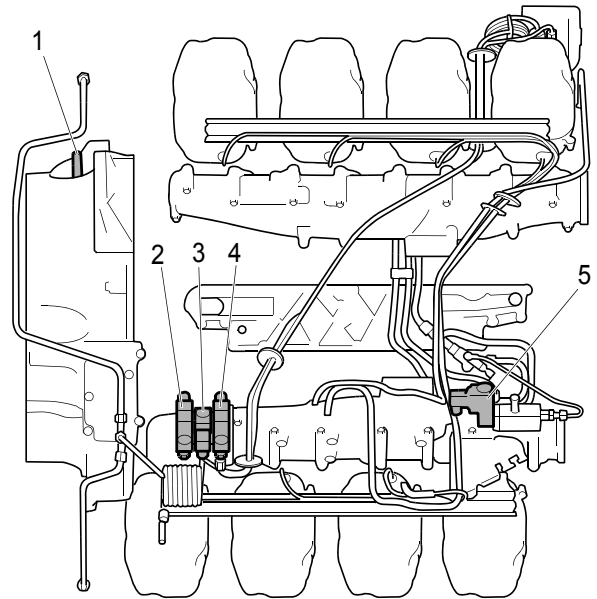

DI16.

- 1. Engine speed monitor, T4005.*
- 2. Oil pressure monitor, T4003.*
- 3. Coolant temperature monitor, T4004.*
- 4. Coolant pressure monitor, T4006.*
- 5. Fuel pressure monitor, T4007.*

347 831



Connecting emergency stop

It is possible to connect an emergency stop which disconnects the voltage to the engine control unit. The connection is made in different ways, depending on whether the system has a safety device unit (SDU) or not.

System with safety device unit (SDU)

Connect a switch with a 10 kohms resistor to connector C4064 in cable harness connected to the safety device unit.

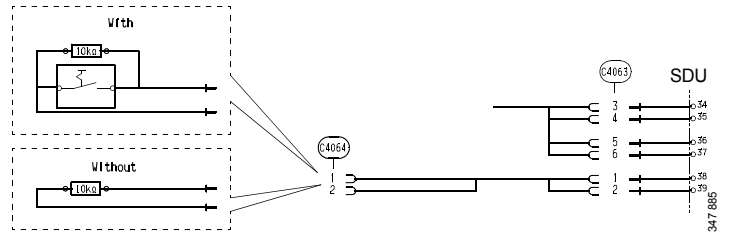

System with safety device unit: connection of emergency stop to C4064.

System without safety device unit (SDU)

Connect a regular open switch to pin 3 in connector C4059 in the junction box. The switch should be connected to 24 V.

Use connector 2 131 199 and the following tools:

- Hand crimping tool 99 494
- Hand crimping tool 99 491

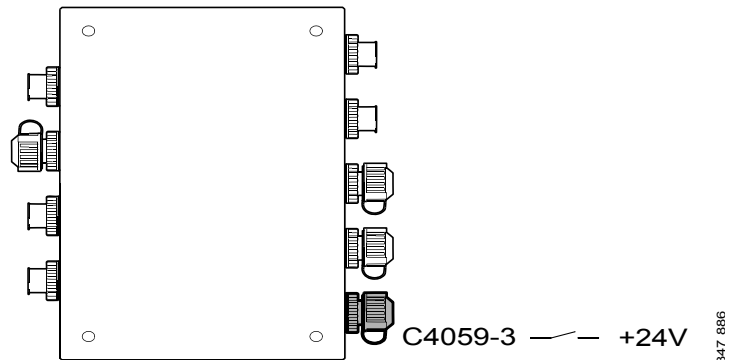

System without safety device unit: connecting an emergency stop to the junction box.



Engine shutdown override in systems with safety device unit (SDU)

It is possible to override engine shutdown requested by the safety device unit in systems prepared for classification. Proceed as follows:

1. Remove the existing 10 kohms resistor between junction blocks 50 and 51 in the safety device unit.
2. Connect a switch with a 10 kohms resistor between junction blocks 50 and 51.

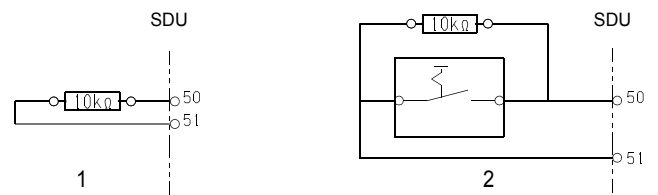

Overriding engine shutdown requested by the safety device unit.

347 888



Using the main display

First start

When you start the main display for the first time or have performed a factory reset, a power-on wizard is displayed. All settings made in the wizard can also be made at a later stage. The first power-on wizard contains the following steps:

1. Calibrate Touch

Calibrate the display by pressing the 5 marks which are displayed one after another. The calibration must be performed correctly in order to continue with the wizard.

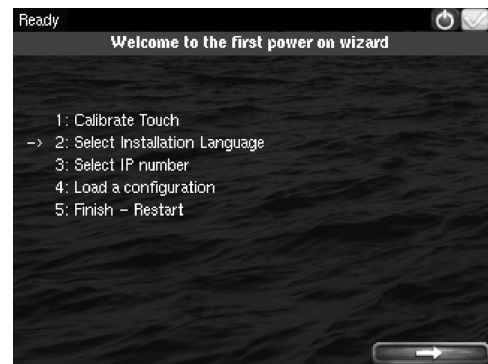

Main display first power on wizard.

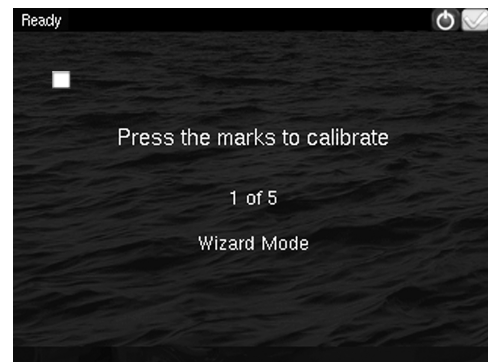

372 511

372 512



2. Select Installation Language

Select the language that should be used during the installation. There are 3 pages of language options.

Note:

In this installation manual, all buttons and options are in English.

3. Select IP number

Enter an IP address. The IP address in the factory settings is 192.168.0.101.

The last 2 numbers in the main display's IP address are displayed as the engine number in the auxiliary display. Example:

- 192.168.0.101 is displayed in the auxiliary display as *Engine #1*.
- 192.168.0.104 is displayed in the auxiliary display as *Engine #4*.

The main display IP address can be changed at a later stage. This is done via *Shortcuts > Menu > Settings > Administration > Network Configuration* in the main display.



REQUIREMENT!

The last numeral in the IP address must always be unique to the network.



372 513

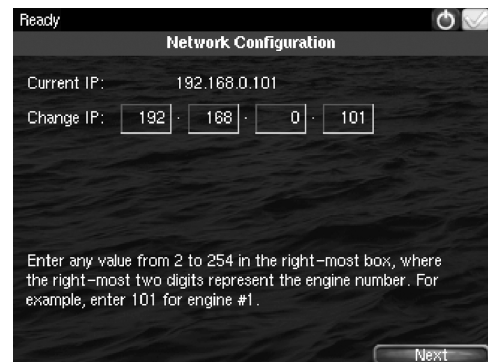

372 514



4. Load a configuration

Load a configuration file depending on whether the system is prepared for classification or not.

1. Press the bar. See illustration.

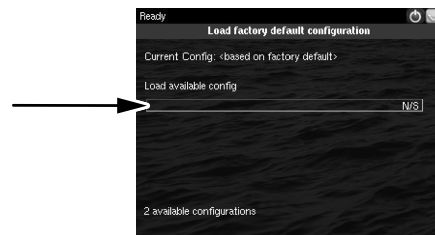

372 515

2. Select one of the available configuration files:

- Non-classified system with gateway for calculation of fuel consumption.
- Non-classified system.
- Classified system with gateway for calculation of fuel consumption.
- Classified system.

3. Press the arrow button.

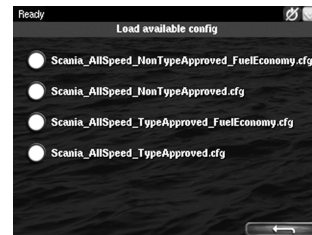

372 516

5. Finish – Restart

Exit the first power-on wizard by pressing *Load* and then *Restart*.

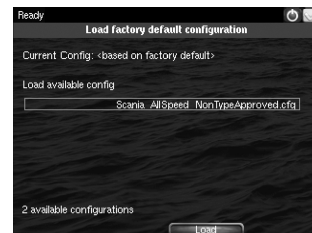

372 517



Navigation

Both the main display and auxiliary display are touch screens, without any buttons. All functions are accessed by pressing the display.

The displays have 5 different display modes:

- Instrument pages
- *Select Page*
- *Shortcut Menu*
- *Alarm List*
- *Menu*

Different touch areas on the display have different functions. For example, if you touch the left-hand side of the display on an instrument page, you get to the previous instrument page. How to navigate:

To get to	Press
<i>Select Page</i>	in the middle of the display
previous instrument page	on the left of the display
next instrument page	on the right of the display
<i>Shortcut Menu</i>	in the top left-hand corner
<i>Alarm List</i>	in the top right-hand corner
<i>Menu</i>	a long press (1 s) in the middle of the display



Instrument pages

The instrument page is the highest level in the main display structure. There are 4 preset instrument pages. It is also possible to configure a further instrument page so that there will be 5 instrument pages in total.

- You scroll between the instrument pages by pressing on the right- or left-hand side of the display.



Example of instrument page.

Select Page

In *Select Page* thumbnails of the instrument pages and the *Shortcuts* menu are shown.

- You get to *Select Page* by pressing in the middle of the display.
- Then select one of the instrument pages from the thumbnails by pressing it.

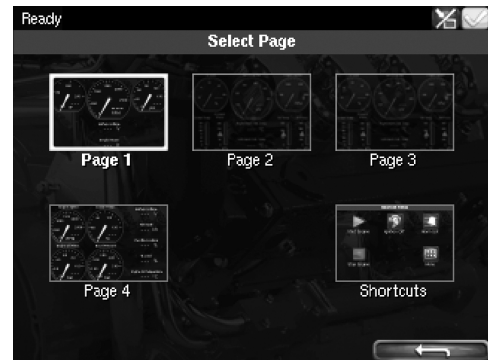



Shortcut Menu

In the *Shortcut Menu*, buttons *Start Engine*, *Stop Engine*, *Alarm List* and *Menu* are available. If the display has software version 2.12, there are also the *Ignition Off* and *Black Panel Mode* buttons.

- Access the *Shortcut Menu* by pressing the upper left-hand corner of the display, or by pressing *Shortcuts* in *Select Page*.

Alarm List

The *Alarm List* is described in the Operator's manual.

Menu

Only the administration section under *Menu > Settings* is described in this manual. Other sections in the *Menu* are described in the Operator's manual.

Note:

You can switch off the button beep by going to *Menu > Settings* and selecting *Disabled* with the *Button Beep* button.

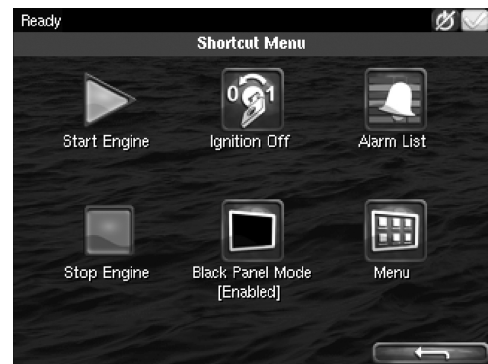



Administration in the main display

Some settings can be made via the main display administration section. How to open the administration section:

- Go to *Select Page > Shortcuts > Menu > Settings*.
- Scroll to page 3 in *Settings* and press *Administration*.
- The administration section is password-protected. Enter the password, which is set at the factory to **1234**.

The administration section consists of three pages and contains the buttons below. The buttons are described in the following section.



Administration in the main display: pages 1, 2 and 3



Password Configuration

This is where you can change the password for access to the administration section. First, you have to enter the existing password.

Configuration Files

This is where you can restore the display to factory settings, load user-configured files or delete user-configured files.

RIO 425

Not used.



372 E22

SDU 410/SDU 404

This is where you synchronise the main display to the safety device unit and vice versa, if the system has a safety device unit.

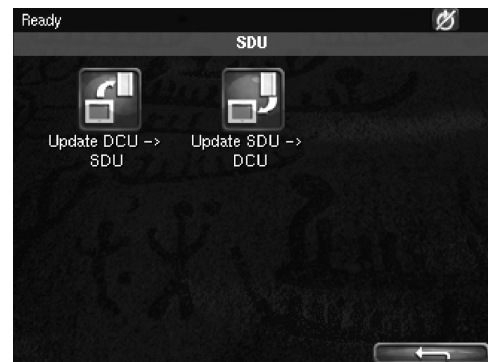

372 E40



Network Configuration

This is where you change the IP address of the main display.

Note:

The last numeral in the IP address becomes the engine number in the auxiliary display.

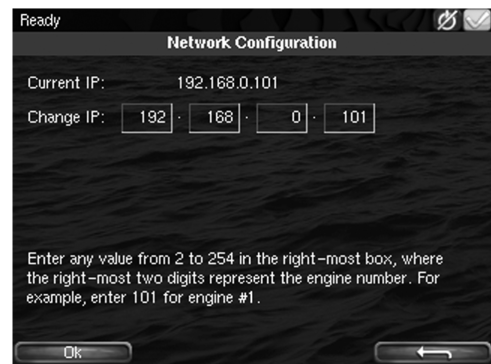

372.056

System Type

This is where control panel settings are made:

Setting	Description
<i>System Without Keypad</i>	System without control panel
<i>System With Keypad at This Station</i>	Control panel connected to this display
<i>System With Keypad at Another Station</i>	Control panel connected to another display

Note:

The default setting is *System Without Keypad*. If the system has a control panel, you must change the default setting.



372.057



Adjust Idle Speed

Adjusting low idling. The following conditions must be met in order to adjust low idling:

- The accelerator control should be at 0% and the engine should be idling.
- The engine coolant temperature should be at least 50°C.

Service Mode

If you activate *Service Mode*, the system is kept active, so that work on the engine control unit, for example, can be carried out. The screensaver timer configured in the *Goto Sleep Time* setting is bypassed. See [Important system settings: dcu / Miscellaneous / System Type](#). The button is only available if the display has software version 2.12.

Automatic Buzzer Silence

Activating and deactivating the automatic buzzer switch-off.

CANbus Amber Lamp

Set how *Amber Lamp* signals that are sent from the engine control unit to the main display should be handled. Select if a warning (yellow alarm) should be displayed in the main display or whether the signal should be deactivated.

CANbus Red Lamp

Set how *Red Lamp* signals that are sent from the engine control unit to the main display should be handled. You can select from the following options:

<i>Disabled</i>	Red alarm via CAN bus deactivated
<i>Alarm</i>	Red alarm via CAN bus activated
<i>Shutdown</i>	Red alarm via CAN bus results in engine shutdown

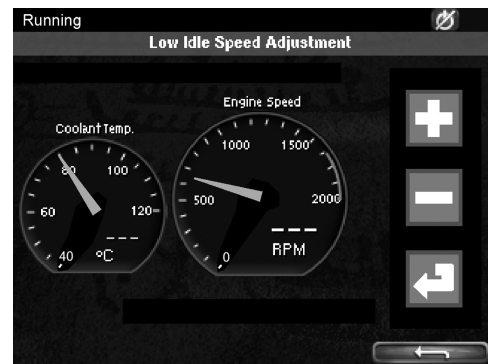

Adjust Idle Speed.



Options for CANbus Red Lamp.

372 523

372 524



Lock

Once the administrator password has been entered, the administration section is unlocked for 1 hour. Press *Lock* to lock the administration section immediately.

Factory Reset

This is where you reset the main display to factory settings.

Configuring and upgrading software with USB memory stick

The USB inputs on the main display and auxiliary display can be used to

- configure the main display,
- upgrade the main display software or an auxiliary display,
- copy an existing configuration file in the main display in order to save a backup copy of the configuration file or transfer the configuration to another display, for example.

Note:

Files to be copied to a display must be saved in the root of the USB memory stick.

Valid characters in the configuration file name are a-z, A-Z, 0-9, _ (underscore) and - (hyphen). If other characters are used, there is a risk that the display may not be able to interpret them.



Configuring the main display with a USB memory stick

1. Insert the USB memory stick with the configuration files into the display.
2. Enter the administrator password (4 digits).
3. The window *USB Storage* is opened. Press *Configuration Files*.
4. The configuration files available on the USB memory stick are listed in the display.
5. Select the file or files you want to copy to the display and press *Copy*.
6. Confirm by pressing *Yes*. The files are not activated, they are only copied to the display.
7. Select the configuration file you want to use and press *Use*.
8. Confirm by pressing *Yes*. The main display will restart.

Different configuration files in the same main display

It is possible to use different configuration files in the same main display. Do this by first copying the configuration files from the USB memory stick according to the instructions above. Then go to *Menu > Settings > Administration > Configuration Files > Load User File* to activate the file you want to use.





Upgrading the main display or auxiliary display software

Note:

If the display is new or has factory settings restored, you must first go through the first power-on wizard before you can upgrade the software.

1. Insert the USB memory stick with the new software version into the display.
2. Enter the administrator password (4 digits).
3. Press *DCU Firmware Files* and follow the instructions on the display.

Note:

When the software has been upgraded, the display will restart. This may take a few minutes. Do not turn off the power until you have waited for at least 5 minutes for the display to restart automatically.

Copying one configuration file in the main display

1. Insert the USB memory stick into the display.
2. Enter the administrator password (4 digits).
3. The window *USB Storage* is opened. Press *Copy Configuration File* and confirm by pressing *Yes*.

The configuration file is now copied to the USB memory stick.





Configuring the main display via a web browser

The main part of this section describes how to configure the main display via a web browser. In the final subsection - *SDU* - some settings of the safety device unit are also described, if the system has one.

The main display is configured using a computer with a web browser via the built in web server of the main display. Therefore, connect a computer to the main display first.

Connecting a computer to the main display

1. In the main display: Go to *Shortcuts > Menu > Help > Version Information*. Make a note of the IP address. The IP address in the factory settings is 192.168.0.101.

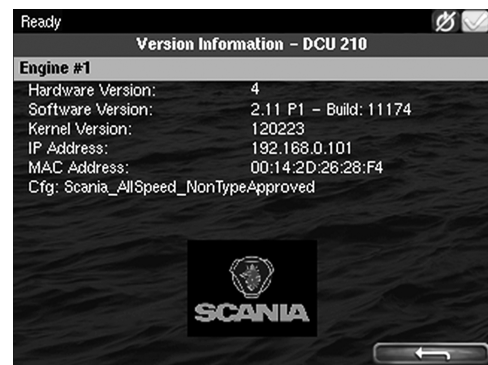

372.526

2. Go to *Shortcuts > Menu > Settings > Connect a PC*.

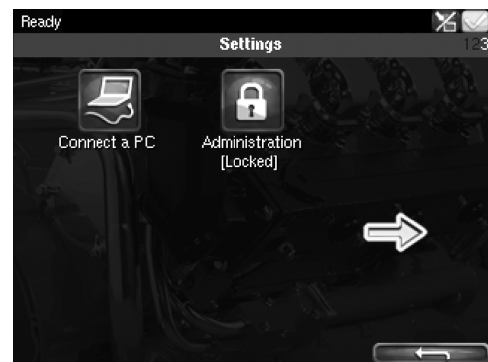

372.527



INSTALLATION MANUAL

Configuring the main display via a web browser

3. Tick the *Enabled* box and press *Ok*.

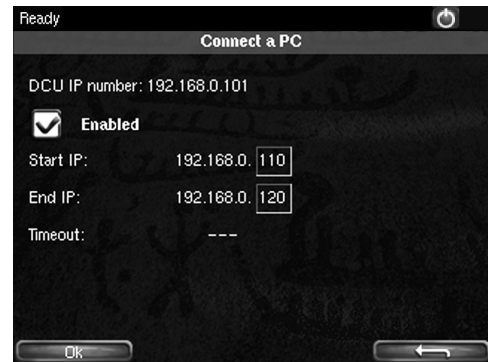

4. Connect an Ethernet cable between the computer and the main display.

5. Enter the IP address in the address field of the web browser; for example: `http://192.168.0.101`, and press Enter.

Approved web browsers:

Web browser	Version
Internet Explorer™	9 or later
Firefox™	8 or later
Chrome™	10 or later

Other web browsers probably also work but have not been tested.

372 528



General information about the IP address

The main display has a fixed IP address, which is set in the first power-on wizard. However, the IP address can always be changed later in the main display administration section:

- In the main display, go to *Shortcuts > Menu > Settings > Administration > Network Configuration*.

Composition of the IP address

Within a network, the first 3 groups of the IP address must always be the same, Example:

192.168.0.X

where X represents another component on the network.

Note:

The last numeral in the IP address must always be unique to the network.

Factory settings for the main display

The factory settings only apply when the main display is started for the first time. When the settings have been changed, the changes are saved even if factory settings are restored.

- *IP-adress:* 192.168.0.101
- *Subnet Mask:* 255.255.255.0
- *Default gateway:* 192.168.0.1



INSTALLATION MANUAL

Configuring the main display via a web browser

Homepage

When you have connected a computer to the main display and entered the IP address, the homepage is displayed. All configurations can be carried out via the built in web interface.

The following menu options are available on the homepage:

Menu option	Description
<i>DCU</i>	To configure the main display. This menu option is described in the following section.
<i>RIO</i>	Not used.
<i>SDU</i>	Safety device unit. This contains information about the safety device unit, some settings can be also be made here. However, as a general rule, no safety device unit settings may be changed. If the settings are changed, the classification may no longer be valid.
<i>Upload Wallpaper</i>	Upload your own background images to the main display here. The file format must be .png.
<i>Versions</i>	Information on the hardware and software version of the main display.
<i>Troubleshooting</i>	Troubleshooting I/O communication in the main display.



344 457



Logging in to the main display

On the homepage: Click *DCU* and then log in to the main display with the following details:

- *User Name*: **dcu**
- *Password*: **1234**

The different configuration menus under *Home > DCU* are described in the following section. The layout of this chapter reflects the menu structure of the web service interface, so that each menu in the illustration on the right has a section of its own. The settings are saved to the main display and not to the computer.

Important system settings: dcu / Miscellaneous / System Type

Some important settings regarding system type, screensaver and password are made in the first step of the configuration. You do not have to change the factory settings, but you should be aware of them.

Setting	Description
<i>System Type</i>	Select <i>System Without Keypad</i> for systems without a control panel. Select <i>System With Keypad at This Station</i> if there is a control panel connected to this display. Select <i>System With Keypad at Another Station</i> if a control panel is connected to another display.
<i>Goto Sleep Time [sec]</i>	Set the timeout for shutting down the system when no control panel is being used (instead of starter key). The setting applies when the system is in <i>Ready</i> mode, i.e. once the engine has stopped. The standard setting is 1,000 seconds.



372 774



INSTALLATION MANUAL

Configuring the main display via a web browser

Setting	Description
<i>Pin Code</i>	Change the system operator password if no control panel is being used. The default setting is 0000.
<i>Pin Code On Wakeup</i>	Specify whether an operator password should be used (instead of starter key) if no control panel is being used.

Password: dcu > Password

The configuration of the main display is password-protected. This is where you change the password for the configuration.

If you have forgotten your password: Click *Get encrypted PIN*. An encrypted password is sent to you. The encrypted password can be decoded. Contact the Scania helpdesk for more information.

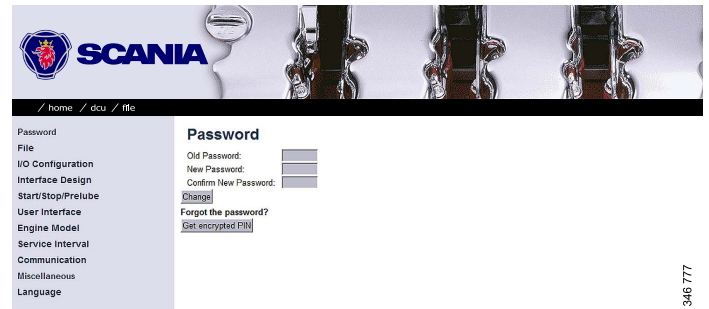

346 777



File management: dcu > File

This menu is used for file management.

Submenu	Description
<i>Load any file</i>	Change the configuration of the main display by activating another configuration file. <i>Factory Default:</i> Activate a factory-configured file. <i>User Uploaded:</i> Activate a user-configured file which has previously been uploaded to the main display via <i>File > Upload to DCU > Configuration</i> . See <i>Upload to DCU</i> below. When you activate the new configuration file, the main display will restart.
<i>Delete configuration file</i>	Remove the user-configured files.
<i>Configuration printout</i>	Take a screenshot.
<i>Save file as...</i>	Save the current main display configuration as a file on the computer. The file is saved in .cfg format.
<i>Upload to DCU</i>	<i>Firmware:</i> Upgrade the software in the main display to the latest version. <i>Wallpaper:</i> Upload your own background images to the main display. The file format must be .png. <i>Configuration:</i> Upload a new configuration file to the main display. Note: The file will be uploaded but not activated. See <i>Load any file</i> above.



346 778

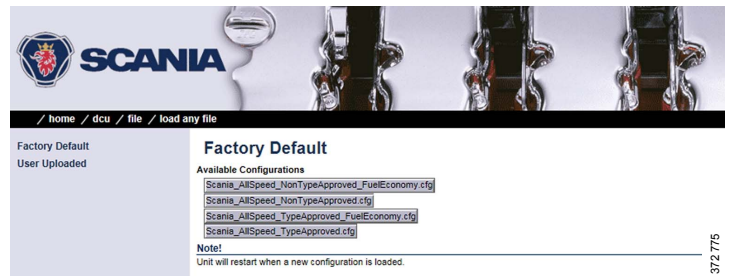

372 775



Configuring input signals: dcu > I/O Configuration > Config Inputs

This is where you configure input signals to the main display.

Enter your own name for all input signals by clicking the *assign custom name* link, at the top of every section.

Note:

Remember to click *Submit* after every change, otherwise they will not be saved.

Engine Speed

This is where the engine speed sensors are configured and the engine overspeed limit value is set.

Source

The main display can receive signals for engine speeds from 3 different sources - *RPM Primary Source*, *RPM Secondary Source* and *RPM Third Source*.

Source	Description
J1939	J1939 CAN bus connected to inputs 25-27.
DCU	Magnetic detection locally connected to inputs 37 and 38.
SDU	Signal from the safety device unit, if the system has one.

The engine speed sources have an order of priority. The main display uses the primary source in the first instance. The secondary source is only used if the main display loses contact with the primary source.

372 776



INSTALLATION MANUAL

Configuring the main display via a web browser

Local Pickup

Enter the number of pulses per engine revolution if a magnetic pulse sensor is connected to the main display, or if *DCU* has been selected from the sources above.

General Configuration

Setting	Description
<i>RPM Rounding</i>	Rounds off the value displayed in the display to 1, 5 or 10 rpm.
<i>RPM Setpoint</i>	States the engine speed at which the starter motor is switched off and the main display indicates that the engine is running.
<i>RPM Setpoint 2-5</i>	Optional engine speed settings which can be used together with other sensors.
<i>RPM Ready To Take Load</i>	A signal that can be configured to an output. The signal is activated when the set engine speed is reached. The signal is deactivated when a stop signal is sent, or when the engine speed drops by 15% or more below the set value.
<i>RPM Nominal Speed</i>	Nominal engine speed. This engine speed is used to calculate the engine overspeed limit value and the engine overspeed test limit value.

The screenshot shows the Scania web browser configuration interface. The page title is "SCANIA" and the navigation path is "/ home / dcu / i/o configuration". The "Engine Speed" configuration section is active, showing the following settings:

- Config Inputs:** Engine Speed, Individual Speed Sensors, Engine Load, Transmission, Switch, 4-20mA, PT100, J1939, Differential, Average, Special, Analog Modbus, Digital Modbus, EGT.
- Config Outputs:** 12/24V Output Functions, Relay Functions, Speed Relays, DM1 Functions, J1939 Outputs.
- Engine Speed Configuration:**
 - assign custom name:
 - Source: RPM Primary Source: RPM Secondary Source: RPM Third Source:
 - Local Pickup: DCU Pickup Pulses Per Revolution:
 - General Configuration: RPM Rounding [RPM]: Run Setpoint / RPM Setpoint 1 [RPM]: (Valid range: 80 - 800 RPM)
 - RPM Setpoint 2 [RPM]: RPM Setpoint 3 [RPM]: RPM Setpoint 4 [RPM]: RPM Setpoint 5 [RPM]:
 - RPM Ready To Take Load [RPM]: RPM Nominal Speed [RPM]: (Valid range: 200 - 3000 RPM)
 - General: Channel Use:
 - Display: Display Range Min [RPM]: Display Range Max [RPM]: Display Major Divider [RPM]: Display Minor Divider [RPM]: Display Multiplier:
 - Overspeed: RPM Overspeed [RPM]: RPM Overspeed Delay [milliseconds]: RPM Overspeed Shutdown Enabled:



General > Channel Use

Select the display in which the signal should be displayed graphically. This display is possible on the main display (*DCU*), auxiliary display (*RP*) or on both simultaneously (*DCU+RP*).

Display

Set the way in which the signal will be displayed on the tachometer.

Setting	Description
<i>Display Range Min</i>	The lowest engine speed displayed on the tachometer, normally 0.
<i>Display Range Max</i>	The highest engine speed displayed on the tachometer. For an engine with a nominal engine speed of 1,500 rpm, the maximum engine speed may be 1,800 rpm, for example.
<i>Display Major Divider</i>	The larger scale marks on the tachometer, i.e. how often the tachometer records an rpm value. A common setting is every 500 rpm.
<i>Display Minor Divider</i>	The minor scale marks between the larger scale marks (<i>Major Divider</i>) on the tachometer. A common setting is every 100 rpm.
<i>Display Multiplier</i>	The multiplication factor displayed on the tachometer, e.g. x100 rpm.

The screenshot shows the Scania web browser configuration interface. The top navigation bar includes the Scania logo and the path: / home / dcu / i/o configuration. The main content area is divided into two columns. The left column lists various configuration categories: Config Inputs (Engine Speed, Individual Speed Sensors, Engine Load, Transmission, Switch, 4-20mA, PT100, J1939, Differential, Average, Special, Analog Modbus, Digital Modbus, EGT), Config Outputs (12/24V Output Functions, Relay Functions, Speed Relays, DM1 Functions, J1939 Outputs), and General. The right column is titled 'Engine Speed' and contains the following settings:

- assign custom name: Source: Engine Speed (J1939)
- RPM Primary Source: None
- RPM Secondary Source: None
- RPM Third Source: None
- Local Pickup: DCU Pickup Pulses Per Revolution: 158
- General Configuration: RPM Rounding [RPM]: 1
- Run Setpoint / RPM Setpoint 1 [RPM]: 400 (Valid range: 80 - 800 RPM)
- RPM Setpoint 2 [RPM]: 0
- RPM Setpoint 3 [RPM]: 0
- RPM Setpoint 4 [RPM]: 0
- RPM Setpoint 5 [RPM]: 0
- RPM Ready To Take Load [RPM]: 400
- RPM Nominal Speed [RPM]: 1800 (Valid range: 200 - 3000 RPM)
- General: Channel Use: DCU+RP
- Display: Display Range Min [RPM]: 0.00
- Display Range Max [RPM]: 2500.00
- Display Major Divider [RPM]: 500.00
- Display Minor Divider [RPM]: 100.00
- Display Multiplier: 1
- Overspeed: RPM Overspeed [RPM]: 2600
- RPM Overspeed Delay [milliseconds]: 100
- RPM Overspeed Shutdown Enabled: No

A 'Submit' button is located at the bottom of the configuration area.

372 776



Overspeed

Setting	Description
<i>RPM Overspeed</i>	The value at which the main display will indicate engine overspeed.
<i>RPM Overspeed Delay</i>	Delay in milliseconds before an alarm or engine shut-down occurs, normally 100 ms.
<i>RPM Overspeed Shut-down Enabled</i>	How the engine should react to engine overspeed. Select <i>Yes</i> if the engine should be shut down at engine overspeed, or <i>No</i> if the engine should not be shut down at engine overspeed.

Individual Speed Sensors

Set the inputs for optional engine speed signals in *Individual Speed Sensors*. Signals coming in via these inputs are handled separately from the engine speed signals that were configured in the previous section.

Engine speed (DCU)

Setting	Description
<i>Channel Use</i>	Select the display in which the signal should be displayed on the tachometer. Display is possible on the main display, on the auxiliary display or on both simultaneously.
<i>Sensor Unit</i>	Only <i>RPM</i> can be selected here.
<i>Sensor Range Min/ Sensor Range Max</i>	These are fixed values that cannot be changed.
<i>Display Unit</i>	Only <i>RPM</i> can be selected.
<i>Display Range Min</i>	Select the lower part of the scale.
<i>Display Range Max</i>	Select the upper part of the scale.
<i>Display Major Divider</i>	Select the larger scale marks, where the rpm value is also shown.

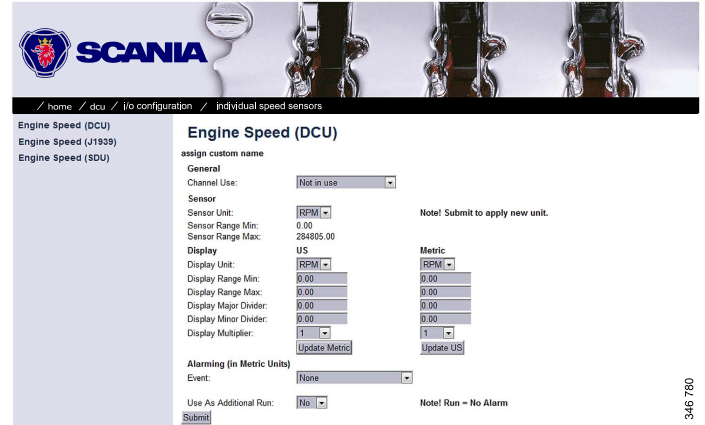



Setting	Description
<i>Display Minor Divider</i>	Select the number of scale marks that should be displayed between the larger scale marks (<i>Major Divider</i>).
<i>Display Multiplier</i>	Select the multiplication factor to be displayed on the display: 1, 10, 100 or 1,000.
<i>Event</i>	Determine how the engine should react to different events for this input.

Engine Speed (J1939)/Engine Speed (SDU)

See previous section.

Engine Load

Select an engine load source in the *Engine Load Source* drop-down list. You can now select engine load as a setting when configuring the alarm.

Transmission

This menu is used to display the gear engaged or to inhibit engine start if a gear is engaged.



INSTALLATION MANUAL

Configuring the main display via a web browser

Switch

In systems with a control panel, the main display has five configurable inputs. If there is no control panel and the software version of the display is 2.12, the five inputs 44-48 are also configurable.

The inputs can be configured so that they are compatible with a regular switch or sensor. They can also be configured to perform a function, e.g. automatic starting. The inputs are activated by applying 24 V to each input.

Note:

Inputs 1-3 (39-41) are reserved in systems with a safety device unit.

Select one of the inputs and configure it according to the instructions below.

Use as

Set the input function. The functions written in **bold** are the most common. Some of the functions are only available if the software version of the display is 2.12.

Setting	Description
<i>None</i>	The input is used as an input for a regular engine sensor.
Local Mode	Sets the display into local mode, i.e. all external commands are blocked.
<i>Remote Mode</i>	External commands are accepted.

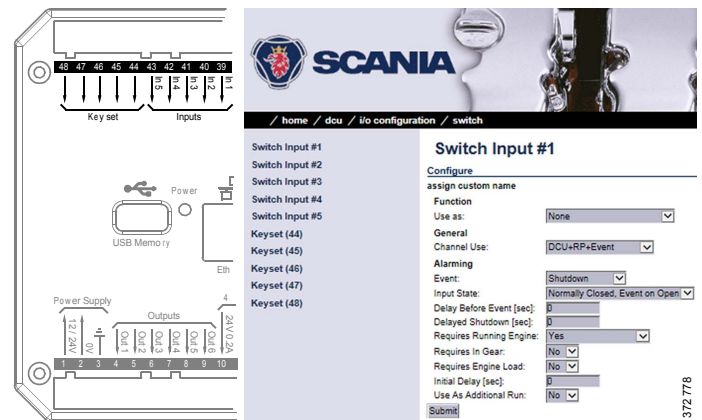



INSTALLATION MANUAL

Configuring the main display via a web browser

Setting	Description
<i>Backlight 100 Percent</i>	Forces the background lighting to light at 100 per cent.
<i>Prelube Override</i>	Not used.
<i>Prelube Complete</i>	Not used.
Start Disabled	Engine start deactivated.
Automatic Mode	The display accepts automatic start and stop signals.
Automatic Start	The display initiates the start sequence. <i>Automatic Mode</i> must be activated.
Automatic Stop	The display initiates the shutdown sequence. <i>Automatic Mode</i> must be activated.
<i>Remote Start</i>	Same as starter button. The display must be in <i>Remote</i> mode.
<i>Remote Stop</i>	Same as stop button. The display must be in <i>Remote</i> mode.
<i>Local Start</i>	Same as starter button. The display must be in <i>Local</i> mode.
<i>Local Stop</i>	Same as stop button. The display must be in <i>Local</i> mode.

The diagram shows the physical terminal with labels for 'Key set' (pins 48-41), 'Inputs' (pins 39-32), 'Power', 'USB Memory', 'Eth', 'Power Supply', and 'Outputs' (pins 1-10). The screenshot shows the 'Switch Input #1' configuration page with the following settings:

- Function: None
- Use as: None
- Channel Use: DCU+RP+Event
- Alarming: Shutdown
- Event: Normally Closed, Event on Open
- Input State: Shutdown
- Delay Before Event [sec]: 0
- Delayed Shutdown [sec]: 0
- Requires Running Engine: Yes
- Requires In Gear: No
- Requires Engine Load: No
- Initial Delay [sec]: 0
- Use As Additional Run: No

372 778



INSTALLATION MANUAL

Configuring the main display via a web browser

Setting	Description
<i>Local Acknowledge</i>	Acknowledge all events in the alarm list. The display must be in <i>Local</i> mode.
<i>Local/Remote Acknowledge</i>	Acknowledge all events in the alarm list.
<i>Remote Acknowledge</i>	Acknowledge all events in the alarm list. The display must be in <i>Remote</i> mode.
Shutdown Override	Allows all configured engine shutdown inputs to become alarm inputs. The engine is then not shut down automatically. Engine shutdown during engine over-speed is however always active.
<i>In Gear</i>	Signal from the gearbox that engine start is not possible due to a gear being engaged. Applies only if the engine drives a propeller. The function can only be configured as <i>Normally open</i> or <i>Normally closed</i> if the software version of the display is 2.12.

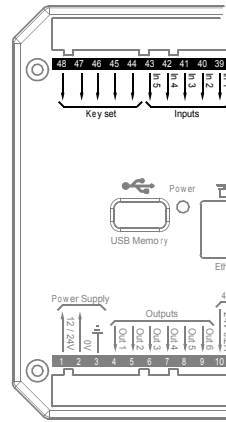

372 778



INSTALLATION MANUAL

Configuring the main display via a web browser

Setting	Description
<i>In Gear (Ahead)</i>	Signal from the gearbox that engine start is not possible due to a forward gear being engaged. Applies only if the engine drives a propeller.
<i>In Gear (Astern)</i>	Signal from the gearbox that engine start is not possible due to reverse gear being engaged. Applies only if the engine drives a propeller.
<i>Toggle Crank Mode</i>	Switch between running the engine normally and with the starter motor only.
<i>Torque Limitation Curve 1-3</i>	Activate torque limitation curve 1-3.
<i>Speed Mode 1-2</i>	Activate engine speed setting 1-2.
<i>Speed Mode Off</i>	Deactivate engine speed setting.
<i>Ignition</i>	Voltage on.
<i>Start</i>	Start the engine.

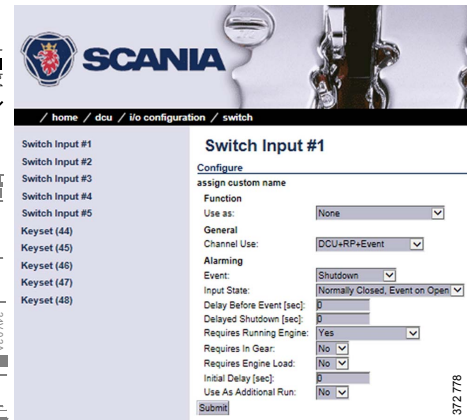
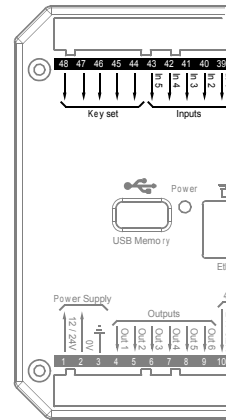

372 778



Channel Use

Set the input should be used.

Event = Warning, alarm or, torque limitation or engine shutdown.

Setting	Description
<i>Not in use</i>	The input must not be used.
<i>Event</i>	The signal will activate an event.
<i>DCU</i>	The signal will only be displayed in the main display.
<i>DCU+Event</i>	The signal will activate an event that is only displayed in the main display.
<i>RP</i>	The signal will only be displayed in the auxiliary display.
<i>RP+Event</i>	The signal will activate an event that is only displayed in the auxiliary display.
<i>DCU+RP</i>	The signal will be displayed in both the main display and auxiliary display.
<i>DCU+RP+Event</i>	The signal will activate an event which is displayed in both the main display and auxiliary display.
<i>Silent Event</i>	The input will be active, but the signal will not trigger any event which is displayed in the display. The signal is only used for communication.

Note:

Select normally *DCU+RP+Event*. Then the signal is displayed on both the main display and the auxiliary display. If the signal only needs to be displayed on the main display, select *DCU+Event*.

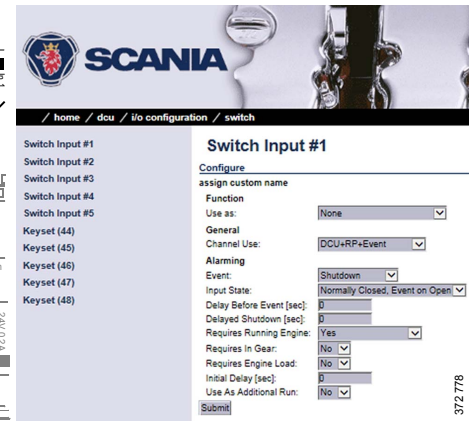
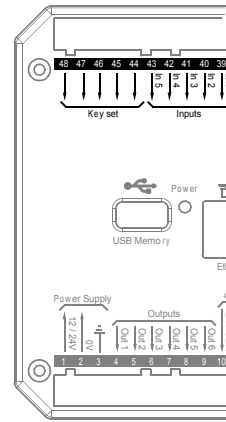

372 778



Event

If you have chosen a type of event (*Event* or *Silent Event*) under *Channel Use*, you should select the type of event here, i.e. warning, alarm or engine shutdown.

If *None* is selected then the input is active but no events are triggered.

Input State

Setting	Description
<i>Normally Closed, Event on open</i>	The switch must be open in order for an event to be triggered.
<i>Normally Open, Event on Closed</i>	The switch must be closed in order for an event to be triggered.

Delay Before Event

If you have selected an event under *Event*, here you enter the desired delay in seconds before the event is triggered.

Delayed Shutdown

If you have selected engine shutdown under *Event*, here you enter the desired delay in seconds before engine shutdown.

Requires Running Engine

Normally, select *Yes* for a pressure sensor and *No* for all other sensors. Select a different value in order to activate the input at another engine speed.

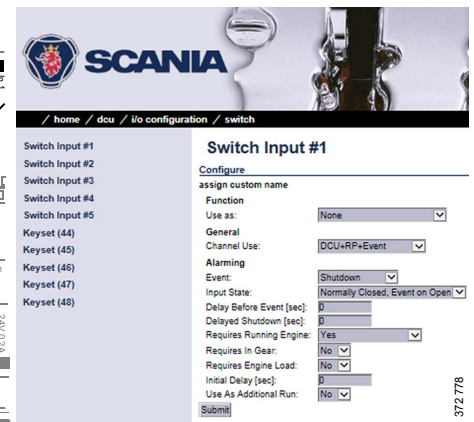
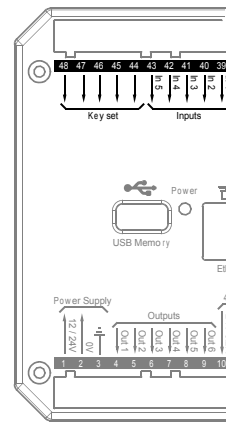

372 778



Requires In Gear

Select *Yes* if an engaged gear is required for an event to be triggered.

Requires Engine Load

Select *Yes* if engine load is required for an event to be triggered.

Initial Delay

Set the delay in seconds before which the input should be activated. This setting can only be made if *Requires Running Engine* is activated.

Use As Additional Run

If the main display only has one engine running indicator, Scania recommends adding the oil pressure sensor as an additional engine running indicator.

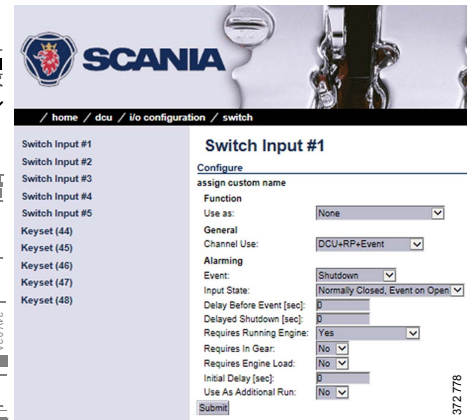
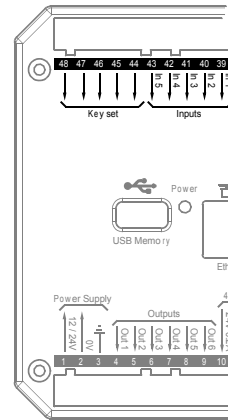

372 778



IMPORTANT!

Use no other pressure sensor signals or other signals as engine running indicator.

- If the main display has two active engine running indicators¹: Select *No*.
- If the main display only has one active engine running indicator: Select *Yes* and use the oil pressure sensor as a further engine running indicator.

1. An engine running signal can be a magnetic sensor or an SAE J1939 CAN bus signal connected to the main display.



INSTALLATION MANUAL

Configuring the main display via a web browser

4-20 mA

First select one of the 4-20 mA inputs. Then configure the input according to the instructions below.

Channel Use

See [Channel Use](#) in the [Switch](#) section.

Sensor

Setting	Description
<i>Sensor Unit</i>	Select the unit indicated on the sensor. An oil pressure sensor can, for example, have bar or psi as units.
<i>Sensor Range Min/Sensor Range Max</i>	Select the sensor measuring range, i.e. the highest and lowest values recorded by the sensor.

Display

Setting	Description
<i>Display Unit</i>	Select the unit in US and Metric to be shown in the sensor display.
<i>Display Range Min/Display Range Max</i>	Select the highest and lowest value in <i>US</i> and <i>Metric</i> that should be displayed on the display for the sensor.
<i>Display Major Divider/Display Minor Divider</i>	Select the desired minor and larger scale marks in <i>US</i> and <i>Metric</i> that should be displayed on the display for the sensor.
<i>Display Multiplier</i>	If necessary, select a multiplication factor. For an instrument with a display range of 0-10,000, e.g. 0-1,000 is displayed with a multiplication factor of 10. The multiplication factor of 10 will then be shown separately on the display (only applies to round dial meters).





INSTALLATION MANUAL

Configuring the main display via a web browser

Setting	Description
<i>Update Metric/Update US</i>	When you have entered all values under either <i>US</i> or <i>Metric</i> , you can calculate the <i>Metric</i> - eller <i>US</i> values automatically by clicking <i>Update Metric</i> or <i>Update US</i> . Note: The values are not rounded. Scania therefore recommends adjusting the values manually afterwards, with a suitable number of decimal places.

Alarming > Event

If you have chosen a type of event (*Event* or *Silent Event*) under *Channel Use*, you should select the type of event here, i.e. warning, alarm or engine shutdown. Select *RPM dependent* if the values should vary according to the engine speed.

PT100

Select one of the PT100 inputs. Then configure in the same way as under the [4-20 mA](#) heading on the previous pages.





J1939

Find the desired signal in one of the following ways:

- Select the first letter of the signal in the column on the left-hand side. Example: If you are looking for the *Fuel rate* signal, select D-F in the left-hand column. Then find the signal in the displayed list.
- Search for the signal by inputting information in one of the fields under *J1939 signal search* and then click *Search*.
- Click *All* in the left-hand column and find the signal in the displayed list.

Configure the signal in the same way as under the heading [4-20 mA](#) on previous pages.

Differential

A differential input is a logical input consisting of 2 physical inputs. The physical inputs can be connected from the J1939 CAN bus. The value of the differential input is made up by the difference between the values of the 2 physical inputs.

Both of the physical inputs must have the same type of sensor. Example: both sensors must send a value in bar. The differential signal can be displayed graphically in the display.

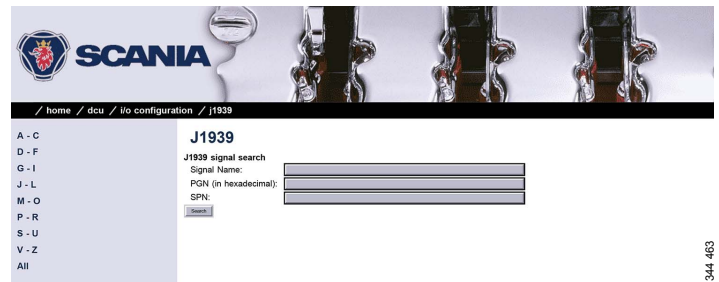

344_463

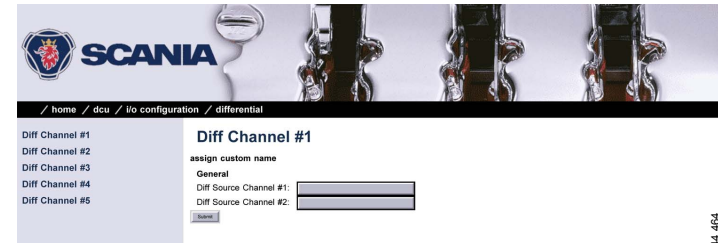

344_464



Special

These are signals which cannot be linked to any other group in a natural manner.

Submenu	Description
<i>Input Voltage</i>	The incoming voltage is monitored with fixed limit values according to the following: Warning: < 21 V Alarm: < 18 V You can add more limit values for warnings and alarms here. It is also possible to set how the voltage should be displayed graphically on the display.
<i>Calc. Fuel Rate</i>	The main display can calculate the fuel consumption and show an approximate value. Select an input and then configure in the same way as under the <i>4-20 mA</i> heading.
<i>Engine Hours</i>	If the engine's hour counter is not available on the J1939 CAN bus, it can be calculated by the main display. This is where you configure how the hour counter should be displayed in the display. The basis for the calculation is inputted via <i>Home > DCU > Miscellaneous > Fuel Consumption</i> .
<i>Instantaneous Fuel Economy (DCU)</i>	The main display can calculate the current fuel consumption using the values for calculated or measured fuel consumption and vehicle speed.

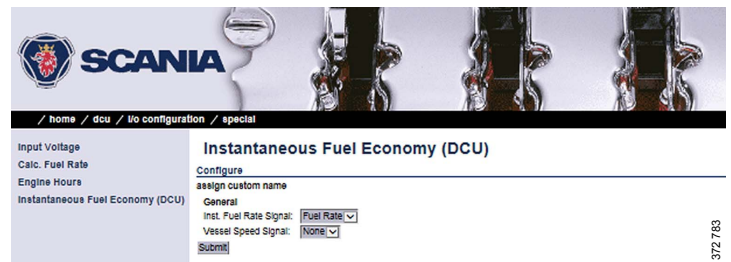
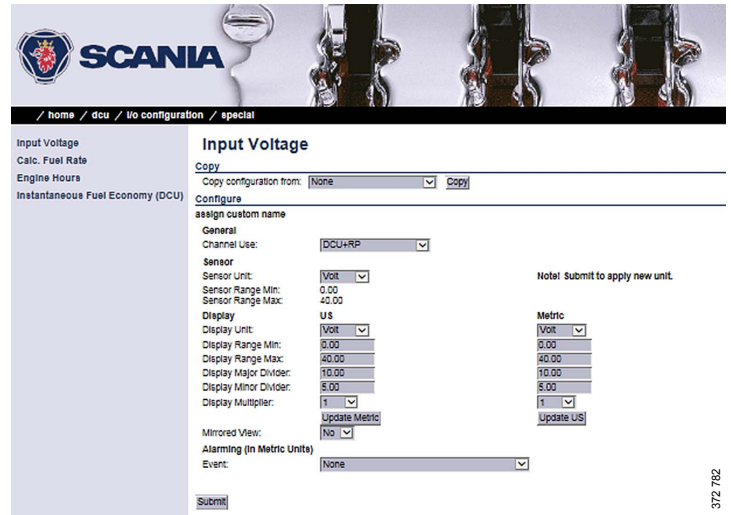



Configure output signals: dcu > I/O Configuration / Config Outputs

The output signals from the main display are configured from here. Enter your own name for all output signals by clicking *assign custom name*, at the top of every section.

Note:

Remember to click *Submit* after every change, otherwise they will not be saved.

The available functions for the outputs are listed in the table. The functions written in **bold** are the most common.

In addition to the fixed functions described in the table, the following functions are also in the list:

- Configured SAE J1939 signals.
- All configured events, e.g. a sensor that has been configured to generate a warning, alarm or engine shutdown.

Function	Description
<i>Acknowledge Button</i>	The acknowledgement button is activated
<i>Buzzer Active</i>	The buzzer is activated
<i>Shutdown in Alarm List</i>	There is an event in the alarm list which has caused an engine shutdown
<i>Alarm in Alarm List</i>	There is an event in the alarm list which has caused an alarm
<i>Warning in Alarm List</i>	There is an event in the alarm list which has caused a warning
All Faults (Unacknowledged)	There is a new event in the alarm list
<i>Common DMI in Alarm List</i>	There is a diagnostic message from the engine control unit in the alarm list
<i>Ready State</i>	The main display is ready
<i>Init. Delay State</i>	The time which should pass between the sending of an automatic start signal and the first start attempt



Function	Description
<i>Cranking State</i>	The main display activates the starter motor
<i>Awaiting Run State</i>	The starter motor has been switched off and the main display is waiting for the engine to rev up
Running State	The engine is running
<i>Crank Delay State</i>	The time which should pass between automatic start attempts with the starter motor
<i>Delayed Stopped State</i>	Status is active and the timer is counting down
<i>Cooling State</i>	The display has activated alternator shutdown and the engine is idling
<i>Stopping State</i>	The engine shuts down
<i>Stopped State</i>	The engine has shut down (engine speed is under 5 rpm) and this status has been active for at least 10 seconds
<i>Blocked State</i>	The engine cannot be started, usually because there is an engine shutdown event which has not been acknowledged
<i>Stopped For Unknown Reason</i>	The display is not receiving signals indicating that the engine is running, but no shutdown command has been sent to the main display. Run out of fuel?
<i>First Start Attempt Failed</i>	The first in a series of automatic start attempts has failed
<i>Final Start Attempt Failed</i>	In a series of automatic start attempts, the last attempt has failed, including the starter motor rest periods between start attempts
In Local Mode	The display is in local mode, i.e. all external commands are blocked.
<i>DCU Tacho Failure</i>	Sensor signal lost during operation
<i>Service Interval</i>	A configured maintenance interval has been reached
<i>Engine Protection Override</i>	The display is in engine shutdown override mode, and engine shutdown signals are now sent as alarms only. Engine shutdown in the event of engine overspeed is always active
<i>Power on</i>	The display has power
<i>Supply Voltage Low</i>	The voltage is under the limit value
<i>Speed Switch 1-4</i>	The function is activated at configured engine speeds.
<i>Alarm or Ack Button or Remote Acknowledge</i>	An acknowledgement is carried out in the display and the buzzer is switched off
<i>Common Start Failed</i>	A collective message indicating that the engine has not started
<i>Common Stop Failed</i>	A collective message indicating that the engine has not stopped, e.g. the stop signal has been activated but the engine has not stopped within the given stop time



Function	Description
<i>Soft Button 1, 2, 3, 4</i>	One of the buttons on the bottom edge of the display is activated
<i>Ready To Take Load</i>	The engine speed is above the set value for <i>Ready to take load</i>
Ready for PMS Start	Active when the voltage is > 21 V and the display is in automatic mode
<i>New Alarm Pulse</i>	When a new event appears in the alarm list, this function is activated for 1 second and is then deactivated automatically
<i>In Manual Mode</i>	The display is in manual mode and cannot start automatically
<i>Overspeed</i>	The engine speed is above the set value for engine overspeed
<i>In Remote Mode</i>	The display can receive remote commands
ETR	Activated when the engine is running or when it is started, deactivated by a stop command
ETS	Activated when the engine receives a stop command and remains active for 10 seconds after the engine has stopped
Shutdown	The engine is shut down automatically by a sensor signal, including engine overspeed
Running	The engine is running
<i>Crank</i>	The display sends a signal to the starter motor to start the engine
<i>Prehube Activation</i>	The display has activated the prelube function
<i>Emergency Start/Mode</i>	The display is in emergency mode, or an emergency start sequence has been activated

12/24V Output Functions

The main display has six 12/24 V outputs. Select one of the outputs, *User Config Output #1* to *User Config Output #6* and set the function it should have by selecting an option in the *Event* drop-down list. Refer to previous pages.

The diagram shows a terminal block with 9 pins. Pins 1, 2, and 3 are labeled 'Power Supply' with '12/24V', '+', and '0V' respectively. Pins 4 through 9 are labeled 'Outputs' as 'Out 1' through 'Out 6'. The screenshot shows the '12/24v output functions' configuration page for 'User Config Output #1', with a dropdown menu set to 'Alarm in Alarm List' and a 'Submit' button.

372 785



Relay Functions

The main display has 2 integrated potential free relay inputs where a function can be connected. Select 1 of the 2 relays and indicate which function it should have. Refer to previous pages.

Speed Relays

A speed relay is a relay that is activated at a certain engine speed and is deactivated below that engine speed. In the example below, *Speed Relay #1* is configured so that it is activated at an engine speed over 1,200 rpm and deactivated under 1,200 rpm. An event is created in the alarm list when the speed relay is activated.

1. Activate the speed relay by selecting *Yes* for *Speed Relay #1 Enabled*.
2. Select *1,200* for *Speed Relay #1 Activate Speed [RPM]*.
3. Select the type of event with *Event*.
4. Select *Yes* for *Event Log*. An event is now created in the alarm list when speed relay 1 is activated.
5. Enter a delay in seconds before which the event should be triggered using *Delay After Crossing Threshold*.

The selected speed relay can now be linked to any configurable output.

J1939 Outputs

Find the desired signal in one of the following ways:

- Select the first letter of the signal in the column on the left-hand side. Example: If you are looking for the *Fuel rate* signal, select D-F in the left-hand column. Then find the signal in the displayed list.
- Search for the signal by inputting information in one of the fields under *J1939 signal search* and then click *Search*.
- Click *All* in the left-hand column and find the signal in the displayed list.
- Configure the signal in the same way as under the [4-20 mA](#) heading.

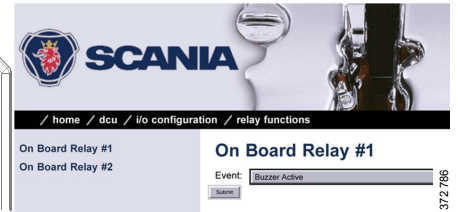
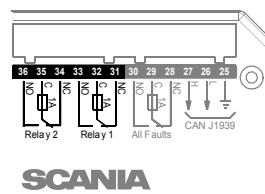

372 786

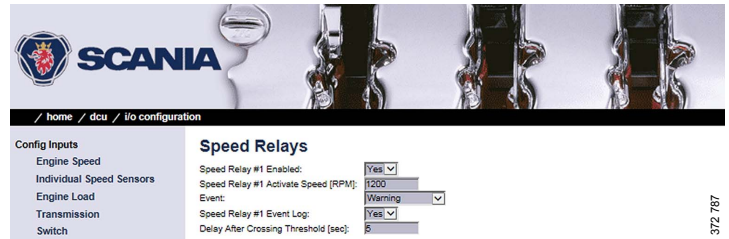

372 787



372 789



Designing instrument pages: dcu > Interface Design

Via *Interface Design* you can add the signals which were configured in *I/O Configuration* to the instrument pages.

Pages

The instrument pages are configured here. The main display can have a maximum of 5 different instrument pages.

This is how an instrument page is constructed:

- Each instrument page (*Page*) is based on a template (*Template*).
- A template has several different areas (*Slots*).
- Each *Slot* can contain one *Widget*. A *Widget* is a gauge needle or a bar, for example.
- Each *Widget* can be allocated one signal.

In the example in the illustration there are four instrument pages. Select one of the instrument pages by clicking it.

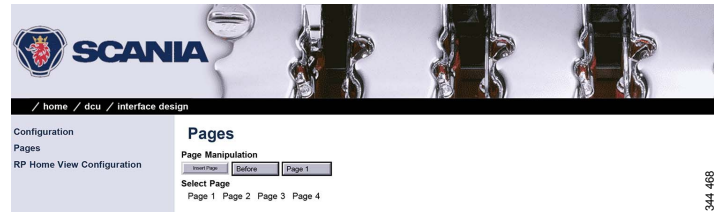



In the example on the right, *Page 1* has been selected. As you can see, this instrument page is based on *Template 14*. There are 9 *Slots* with one *Widget* in each *Slot*. *Slot 1*, 2, 3, 6 and 7 are each assigned a signal.

Adding a signal to a Slot

- Under *Populate Slots*, select a signal by clicking the drop-down list for the desired *Slot*. Only the signals configured for use are displayed in the drop-down list.

Changing a signal

- Click *Edit Signal* to the right of the desired *Slot*.

Adding a new instrument page

- Under *Page Manipulation* at the top of the window, select whether the new instrument page should be displayed before or after one of the existing instrument pages. Then click *Insert Page*. The instrument pages are automatically renumbered.
- Select a template for the current instrument page by clicking one of the templates displayed under *Select Template*. The *Template* currently selected for the instrument pages is displayed at the bottom of the window under *Current template*.
- Configure the instrument page according to the description above and click *Submit* when finished.

Deleting an instrument page

Select the instrument page you want to delete under *Select Page* and click *Delete Current Page* at the bottom of the window. The instrument pages are automatically renumbered.

Check that you are deleting the correct instrument page, as there is no Undo function.

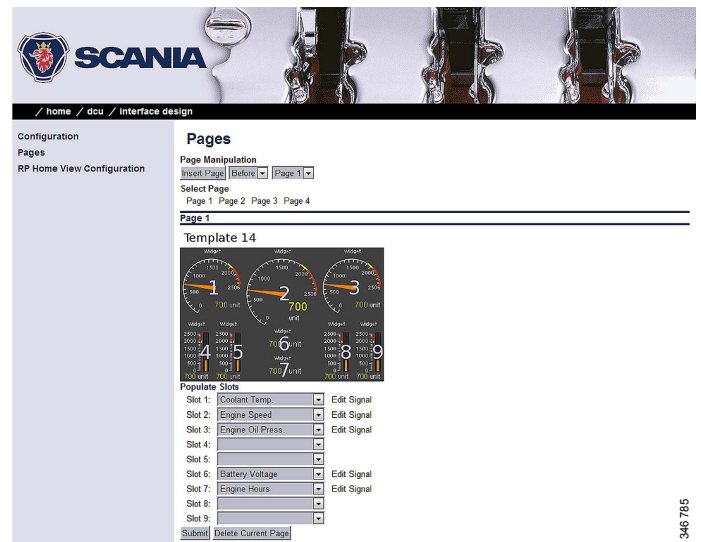



Set the sequences for starting, stopping and for lubrication: dcu > Start/Stop/Prelube

Set manual and automatic engine start and shutdown sequences.

General/Prelube

The following general settings under *General* and *Prelube* cannot be changed:

Setting	Description
<i>Hold Button to Start/Stop</i>	Must be <i>Yes</i> .
<i>Allow E-Start</i>	Must be <i>No</i> .
<i>Prelube Type</i>	Must be <i>No Prelube</i> .
<i>Oscillating Prelube</i>	Must be <i>No</i> .

The screenshot shows the Scania web browser configuration interface. The top navigation bar includes the Scania logo and the path: / home / dcu / start/stop/prelube. The main content area is titled "Settings" and is divided into several sections:

- General**
 - Hold Button to Start/Stop: Yes (dropdown)
 - Allow E-Start: No (dropdown)
 - Only Allow Local Start in Local or Emergency Mode: Yes (dropdown)
 - Prohibit Crank Above RPM Threshold [RPM]: 5 (dropdown)
- Prelube**
 - Prelube Type: No Prelube (dropdown)
- Oscillating Prelube**
 - Oscillating Prelube: No (dropdown)
- Automatic Start**
 - Initial Start Delay [seconds]: 1 (input field)
 - No. of Start Attempts: 3 (input field)
 - Prelube Before Each Start Attempt: No (dropdown)
- Starter**
 - Cranking Time [seconds]: 7 (input field)
 - Delay Between Start Attempts [seconds]: 7 (input field)
- Automatic Stop**
 - Delay Before Disconnecting Generator Breaker [seconds]: 100 (input field)
 - Cooling Time [minutes]: 3 (input field)
- Stopping**
 - Stopping Time [minutes]: 1 (input field)
 - Safety Stopping Time [seconds]: 30 (input field)

A "Submit" button is located at the bottom of the settings area. A note on the right side of the "General" section states: "Note: Max 60s cranking time."



Automatic Start/Starter

The main display can start the engine automatically. The following conditions must then be met:

- An input must be configured as automatic start and activated.
- The main display must be in automatic mode in *Menu > Settings > Operation Mode*.

Setting	Description
<i>Initial Start Delay [seconds]</i>	When the start sequence is activated, this amount of time must have passed before the main display performs the first attempt to start. Normal setting: 1 second.
<i>No. of Start Attempts</i>	The total number of start attempts. Normal setting: 3 start attempts.
<i>Prelube Before Each Start Attempt</i>	Not used, must be <i>No</i> .
<i>Cranking Time [seconds]</i>	The time the starter motor should be activated. Normal setting: 5-7 seconds.
<i>Delay Between Start Attempts [seconds]</i>	If the engine did not start during a previous start attempt, this setting dictates the time until the next start attempt. Normal setting: 5-7 seconds.

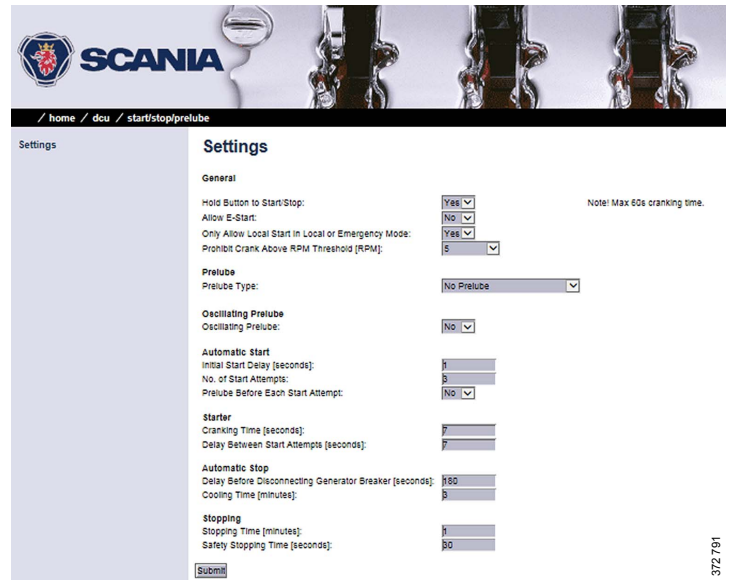

372 791



Automatic Stop/Stopping

The main display can shut down the engine automatically. The following conditions must then be met:

- An input must be configured as automatic stop and activated.
- The main display must be in automatic mode in *Menu > Settings > Operation Mode*.

Setting	Description
<i>Delay Before Disconnecting Generator Breaker [seconds]</i>	When automatic stop is activated, the main display waits for the number of seconds set here before sending the signal indicating that the alternator's battery master switch is to be disconnected. The <i>Disconnect Generator Breaker</i> signal is not a standard output signal. It must be configured to a 24 V output or a relay output. Normal setting: 1-60 seconds.
<i>Cooling Time [minutes]</i>	When a time setting has been exceeded, the engine continues to run without load for the time set here. Normal setting: 1-10 minutes.
<i>Stopping Time [minutes]</i>	Maximum stop time before the engine control unit sends an alarm that the engine has not shut down. Normal setting: 30 s.

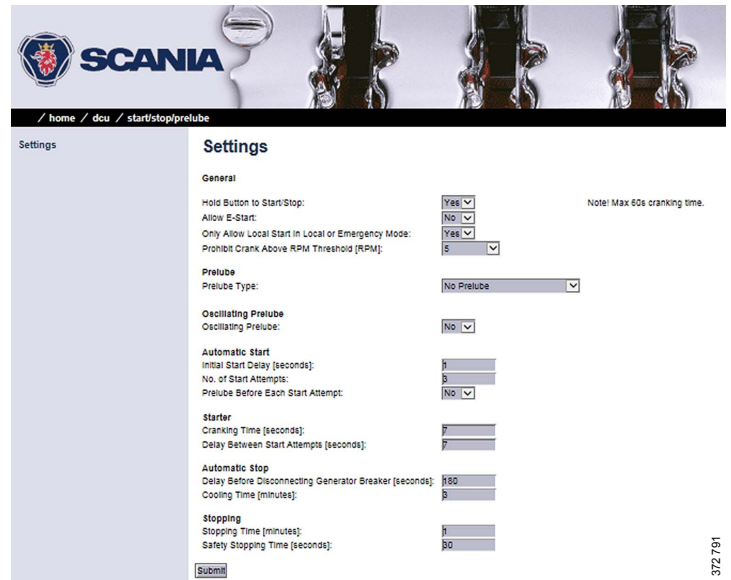



Settings for the user interface: dcu > User Interface

Language and buzzer settings are made here.

Language

This is where you translate signal descriptions manually to other languages. The translated signal descriptions are then displayed in the displays.

All signals

By clicking *All signals*, all signals that are available in the main display are displayed. 3 text columns describing the signals are displayed. Example:

English Default	English Used	Norwegian used
Engine Oil Press.	Engine Oil Pressure	Motoroljetrykk
Engine Speed	[default]	Motorturtall

The columns contain the following descriptions:

- **English Default:** The text used if no change is made.
- **English Used:** The text which will actually be displayed on the display. If *[default]* is displayed, the description in *English Default* is used.
- **Norwegian Used:** The text displayed on the display when the operator has selected this language (in this case Norwegian).

Click the signal description you want to change.

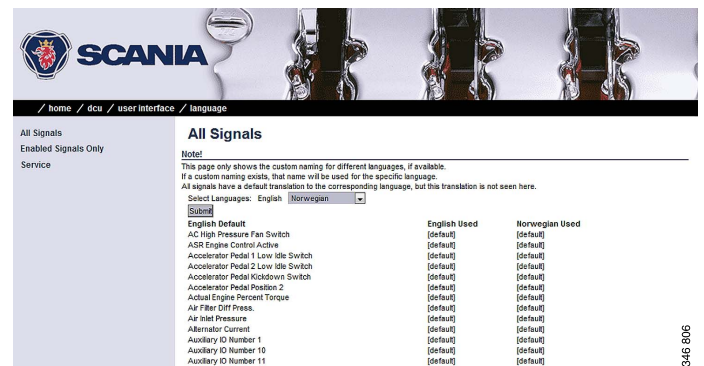

909 806



Enabled Signals Only

This section works in the same way as *All signals*. The difference is that only the signals which are used are displayed.

Service

Not used.

Buzzer

Set how the buzzer should be used in the display.

Select *Yes* under *Automatic Buzzer Off* if you want the buzzer to be switched off automatically. The buzzer is then activated as previously, but the main display will automatically switch it off after 0.5 seconds.

The function is designed to be used during configuration, when accidental alarms may occur. It is automatically deactivated after 1 hour.

Changing the engine designation: dcu > Engine Model

Here you can change the name of the engine to a more suitable name, e.g. "Hjälpmotor" or "Vabis". The default name is "Engine".

The last 2 numbers in the main display's IP address show the engine number. Example: If the IP address is 192.168.0.110, then the engine in the previous example will be called "Auxiliary #10" or "Vabis #10". The name of the engine is displayed in the auxiliary display.

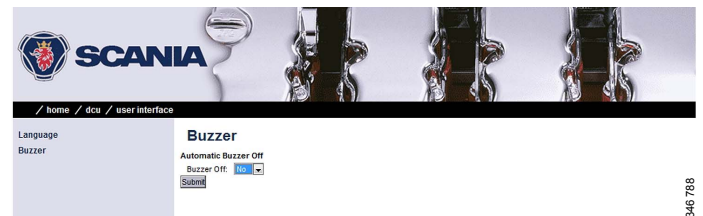

346 788

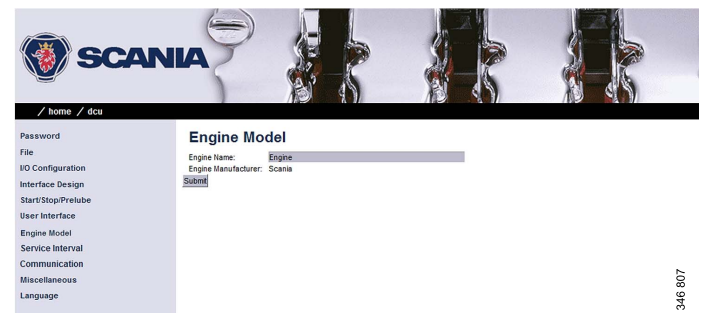

346 807



Setting the maintenance interval: dcu > Service Interval

Set a maintenance interval at the request of the customer. There are no default settings.

In the *View Service Status* submenu, the number of hours until the next maintenance is displayed. All values displayed are operating hours for the engine.

You can set up to four different maintenance intervals in the *Configure* submenu. You can change the text for *Service x* by clicking the *assign custom name* link.

Setting	Description
<i>Service Enabled</i>	Activate the maintenance interval with <i>Yes</i> .
<i>Next Service At</i>	Enter a value for the first maintenance in the main display hour counter. The setting only gives one maintenance notification for the first maintenance. This setting is useful if the first maintenance is to take place within a shorter interval than the normal maintenance interval.
<i>Then Every</i>	Enter a maintenance interval in hours. The main display indicates whenever a maintenance interval is due to expire. Example: The main display has a timer setting of 140 h. The next maintenance is at 150 h. The next maintenance then occurs every 250 h. The first maintenance reminder is displayed in the main display after 10 h. A reminder is then displayed every 250 h.

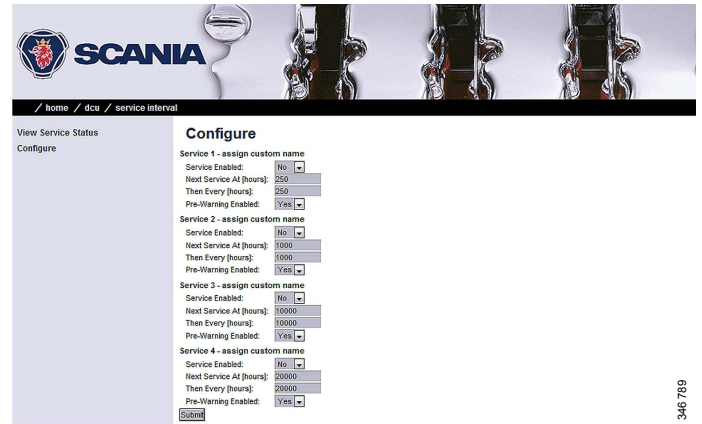



Network settings: dcu > Communication

Network Configuration

The IP address, netmask and gateway for the main display are entered here.

Check that the IP address is unique for the network. If the main display is to be installed in an existing network: Contact your network manager to receive an IP address.

Modbus RTU

The main display has a built-in Modbus RTU interface.

Modbus parameters

Transfer speed	19,200
Data bits	8
Stop bit	1
Parity	Even

Setting	Description
Address	Modbus identity number for the RS-485 channel. The ID number can be any integer between 1 and 247. It must also be unique to the network.

Modbus I/O list

The I/O list for communication is at this address: <http://bit.ly/K411bK>

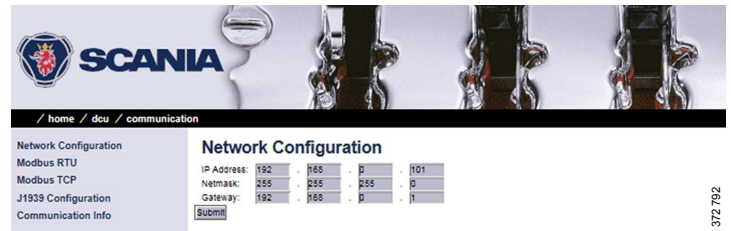

372 792



J1939 Configuration

This is where you configure how the SAE J1939 CAN bus should work.

Submenu	Description
Source address	The preset source address for the display is 27 (Hex).
Allowed Addresses	Filtering units on the CAN bus so that the main display can read data from selected units. Normally, all sources are accepted.
Allowed DMI Addresses	Filtering units on the CAN bus so that the main display can read data from selected units. Normally, all sources are accepted.



372793



Other functions: dcu > Miscellaneous

This is where other functions are configured.

Alarm Configuration

This is where you configure how the SAE J1939 CAN bus should work in the event of an alarm.

Setting	Description
<i>J1939 CANbus Broken Wire Alarm When Engine Not Running</i>	The setting should be <i>No</i> .
<i>J1939 CANbus Red Lamp Severity</i>	Set how <i>Red Lamp</i> signals that are sent from the engine control unit to the main display should be handled. Select <i>Disabled</i> if the main display should disregard red alarms. Select <i>Alarm</i> if a red alarm should be triggered or <i>Shutdown</i> for engine shutdown.
<i>J1939 CANbus Amber Warning Lamp Enabled</i>	Set how <i>Amber Lamp</i> signals that are sent from the engine control unit to the main display should be handled. Select if a warning (yellow alarm) should be displayed in the main display or whether the signal should be deactivated.
<i>RP Lost Warning Enabled</i>	Use this setting if a warning should be displayed if communication with the auxiliary display is broken.

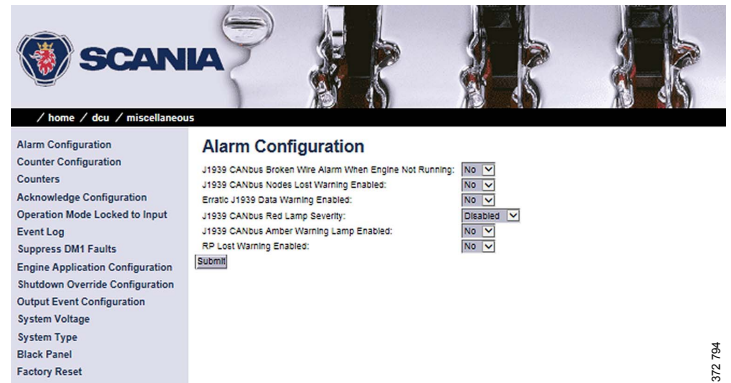



Counters

No changes may be made. The source for calculating the engine operating time should come from the J1939 CAN bus. All changes that are made under *Update Local Engine Hours* will be overwritten by the J1939 CAN bus.

Fuel Consumption

This submenu is only available if the display has software version 2.11 or earlier.

The main display can calculate an approximate fuel consumption. For this to work, you must fill in the calculation configuration with input data from the engine specification. You must also configure the signal in the *Special* menu under *I/O Configuration*.

Acknowledge Configuration

If you activate the function by selecting *Yes*, all alarms are acknowledged at once when the operator presses the acknowledge button for one second. The standard setting is *No*. If there are more alarms in the alarm list than those displayed in the display, the alarms which are not displayed are also acknowledged.



372 795



Event Log

The main display has a log where all events are saved. Set how the log should be displayed.

Setting	Description
<i>Everything</i>	A list of all events in chronological order.
<i>Alarms Only</i>	A list of all warnings, alarms and engine shutdowns.
<i>User Interaction Only</i>	A list of all buttons pressed on the display.
<i>Commands Only</i>	A list of all executed remote commands on the main display.
<i>Events Only</i>	A list of all events that are not alarms, e.g. power on.
<i>Sequence Only</i>	
<i>Save as...</i>	Save the list displayed to the computer as a text file.

Suppress DM1 Faults

Enter the combinations of SPN and FMI messages which are not to be displayed on the main display.

Engine Application Configuration

Set how the engine should be used. Depending on the settings made here, the operator can select from the display modes offered.

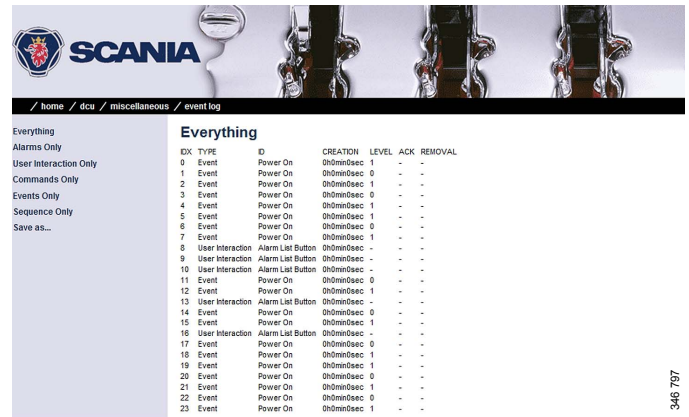

346 797



Shutdown Override Configuration

Setting	Description
SDU	
<i>Transmit Shutdown Override to SDU</i>	Signal to the safety device unit to override engine shutdown.
J1939	
<i>Transmit Shutdown Override [SPN 1237]</i>	Signal to override engine shutdown to engine control unit via the CAN bus.
<i>Shutdown Override from J1939</i>	Signal to override engine shutdown from engine control unit via the CAN bus.



372 796

System Voltage

The system voltage must always be set to 24 V.

System Type

More information can be found under the heading [Important system settings: dcu / Miscellaneous / System Type](#).



Black Panel

Configuration

The screensaver function for improved night vision can be activated here by selecting *Yes* under *Black Panel Support*. When the function is activated, the display comes on at minimum brightness if the operator touches the display and the alarm. It is then turned off again after the number of seconds you have set in *Timeout*.

DM1

Enter which combinations of SPN and FMI messages should switch the screen on when the screensaver function is activated.

Factory Reset

Perform a factory reset of the main display. After resetting, the main display restarts.



372.797

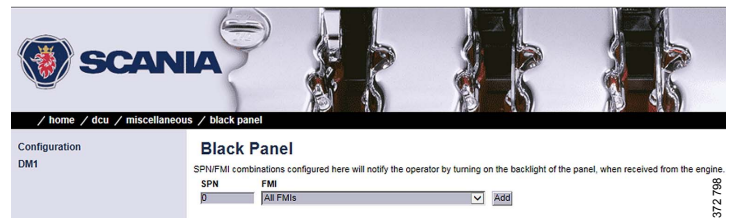

372.798



INSTALLATION MANUAL

Configuring the main display via a web browser

SDU

Under *Home* > *SDU*, there are settings for the safety device unit, if the system has one.

! IMPORTANT!

The settings in the *Speed Sensor* submenu must not be changed. If changes are made, this affects the type approval of the system.

The settings for Switch 1-4 in the *Switch* submenu must not be changed. If changes are made, this affects the type approval of the system.

Switch 5-8 can be configured according to customer wishes or type approval requirements, e.g. monitoring of oil pressure in reverse gear.

The screenshot shows the Scania web interface for configuring SDU Switch #5. The breadcrumb path is "/ home / sdu / switch". A sidebar on the left lists SDU Switch #1 through #8. The main content area is titled "SDU Switch #5" and includes an "assign custom name" field. Under the "General" section, there are several settings: "Password Protected:" (Unknown), "Enabled:" (No), "On RUN Only:" (No), "Shutdown Override Disabled:" (No), "Enable Speed Dependency:" (No), and "Delay Time [sec]:" (1). A "Valid range: 1 - 255" is indicated for the delay time. A "Submit" button is at the bottom.

347 894

The screenshot shows the Scania web interface for configuring Miscellaneous settings. The breadcrumb path is "/ home / sdu / sdu 404". A sidebar on the left lists various menu items: Version, Speed Sensor, Switch, Miscellaneous, Output Functions, and Synchronize. The main content area is titled "Miscellaneous" and includes an "Input Power" section with "Power Low Threshold [Volt]:" (0.00), "Power Low Delay [sec]:" (10), "Power Very Low Threshold [Volt]:" (0.00), and "Power Very Low Delay [sec]:" (10). A "Valid range: 10-60 sec" is indicated for the delays. The "Misc" section includes "Allow Load Reduction Override:" (No), "Automatic Buzzer Off:" (No), "Input Switches", "Shutdown Override Switch Type:" (Type I (Short Circuit and Broken Wire detectable)), "Shutdown Override Switch Enabled:" (No), "Acknowledge Switch Type:" (Type I (Short Circuit and Broken Wire detectable)), and "Acknowledge Switch Enabled:" (No). A "Submit" button is at the bottom.

372 799



Auxiliary display

The auxiliary display reads the configuration from the main display when it is connected to the main display. It does not therefore need to be configured separately. Navigation in the auxiliary display works in the same way as the main display. Information on navigation is under the heading [Navigation](#).

First start

When the main display is started for the first time or after a factory reset, a power-on wizard is displayed. All settings which can be made in the wizard can also be made at a later stage. The first power-on wizard contains the following steps:

1. Calibrate Touch Screen

Calibrate the display by pressing the 5 marks which are displayed one after another. The calibration must be performed correctly in order to continue with the wizard.

2. Select Installation Language

Select the language that should be used during the installation.

3. Select Administrator Password

Enter a new administrator password in this step. First enter the preset password, i.e. 1234. A prompt to enter a new administrator password will follow. You must enter the password twice.

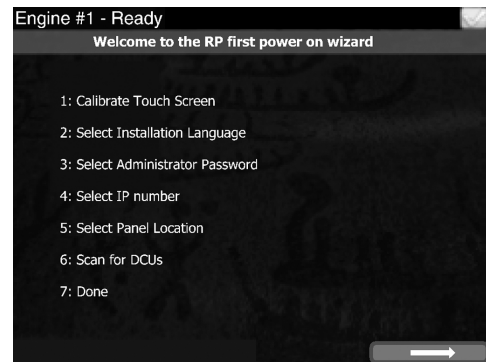

First power-on wizard for the auxiliary display.



4. Select IP number

Enter an IP address. The IP-address in the factory settings is 192.168.0.201.

REQUIREMENT!

The last numeral in the IP address must always be unique to the network.

5. Select Panel Location

Select where the auxiliary display is to be located. The information is only used by other auxiliary displays.

6. Scan for DCUs

Search for main displays on the network by pressing *Search*. An extra display can only be connected to a main display.

If the main display is not ready at this point, continue with the wizard. The connection to the main display may be made on a later occasion.

7. Done

The First power-on wizard is complete. If no main display is connected, the extra display's menu will now be shown.

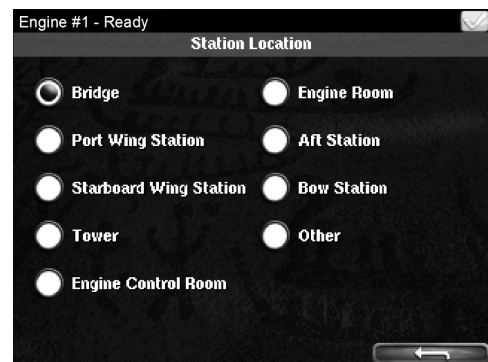

Options for Select Panel Location.



Administration in the auxiliary display

This section describes how to connect the auxiliary display to the main display and make settings which are unique to the auxiliary display. How to open the auxiliary display administration section:

1. Go to *Select Page > Shortcuts > Menu > Settings*.
2. Press *Administration*.
3. Enter the password you set in the auxiliary display power-on wizard.

The administration section consists of three pages and contains the buttons below. These are described in the following section.



Administration in the auxiliary display: pages 1, 2 and 3



DCU Connection

Connect the auxiliary display to the main display as follows:

1. Press *DCU Connection*.
2. Press *Search*. A list of available main displays on the network is displayed.
3. Select the main display for the engine you wish to connect and press *Ok*.

Note:

You must actively select the required main display. If you press *Ok* without selecting a display, the auxiliary display will not be able to connect, even if only one main display is listed.

The auxiliary display connects to the selected main display and the instrument pages of the main display are displayed.

DCU Alarms

Set whether the alarms triggered in the main display should be displayed in the auxiliary display or not.

- Select *Enabled* if you want all alarms triggered in the main display to be displayed in the auxiliary display.
- Select *Disabled* if you do not want alarms triggered in the main display to be displayed in the auxiliary display.





DCU Acknowledge

Determine how main display alarm acknowledgements can be handled from the auxiliary display. You can make the following settings:

Setting	Description
Acknowledge Mode	
<i>Not Allowed</i>	Select this option if no alarms should be acknowledged from the auxiliary display. Alarms can then only be acknowledged from another display.
<i>Silence Only</i>	Select this option if it should be possible to disable the buzzer without acknowledging any alarms in the auxiliary display.
<i>Ack & Silence</i>	Select this option if all alarms should be acknowledged from the auxiliary display in the same way as in the main display.
Acknowledge Options	
<i>Allow Acknowledge All</i>	Tick this check box if it should be possible to acknowledge all alarms at the same time. Acknowledgement is then carried out with 1 long press (1 s) on the acknowledgement button. Untick this check box if only one alarm at a time should be acknowledged.

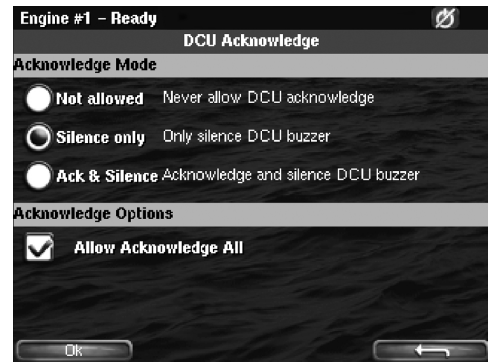

Options for DCU Acknowledge.



IP Address

Change the IP address of the auxiliary display if necessary.

Note:

- The first 3 numbers in the IP address must be the same for all displays on the network.
- The last numeral in the auxiliary display IP address must be unique to the network.

You do not need to reconnect to the main display once you have changed the IP address.

System Type

Make settings for the control panel:

Setting	Description
<i>System Without Keypad</i>	System without control panel
<i>System With Keypad at This Station</i>	Control panel connected to this display
<i>System With Keypad at Another Station</i>	Control panel connected to another display

Note:

The default setting is *System Without Keypad*. If the system has a control panel, you must therefore change this setting.



372 534



372 057



Adjust Idle Speed

Adjusting low idling. The following conditions must be met in order to adjust low idling:

- The accelerator control should be at 0% and the engine should be idling.
- The engine coolant temperature should be at least 50°C.

Cameras

This function is not supported.

Station Location

Select an option for the location of this auxiliary display. The information is only used by other auxiliary displays.

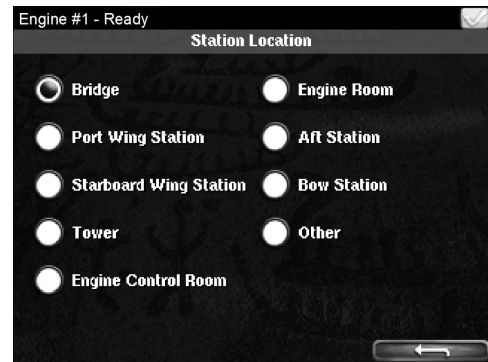

Options for Station Location.

372 530

Functional Outputs

When an alarm or a fault code appears during driving in *Black Panel* mode, you can select whether it should switch on the display or not. With alarms and fault codes which do not switch on the screen, you can activate an output which switches on a light, for example, here. The button is only available if the display has software version 2.12.

Change Password

Change the administrator password. If you enter the wrong password, an encrypted password is sent. The encrypted password can be decoded. Contact the Scania helpdesk for more information.



372 539



Station Priority

Enter the priority the auxiliary panel should have on the network. This setting controls how the auxiliary panel works together with other auxiliary panels on the network.

How to select the correct priority:

- Select *Priority 1* if this auxiliary display is the only auxiliary display on the network.
- Select *Priority 1* or *Priority 2* if there are other auxiliary displays on the network than this auxiliary display.
- Select *Priority 3* if this auxiliary display should only be used for monitoring.

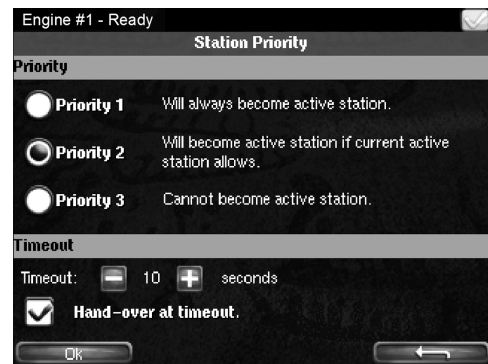

372 535

	Priority 1	Priority 2	Priority 3
Description	Select this option if this auxiliary display should have the highest priority, e.g. if it is to be located in the engine compartment. Also choose <i>Priority 1</i> if there is only one auxiliary display on the network.	Select this option if this auxiliary display should have a lower priority, e.g. if it is to be located on the bridge.	Select this option if this auxiliary display is to be located in a public area, where no commands should be executed.
Function to take control	An auxiliary display with priority 1 can always take control from the auxiliary display which is the active display. If the operator tries to execute a command on an auxiliary display with priority 1 which is not the active display, it will immediately become the active display and execute the command.	An auxiliary display with priority 2 can take control from an active display with priority 1 or 2 if confirmed on the active display.	An auxiliary display with priority 3 can never become an active display.



	Priority 1	Priority 2	Priority 3
Function to hand over control	An auxiliary display with priority 1 will immediately hand over control to another auxiliary display with priority 1. If control is handed over to an auxiliary display with priority 2, this is due to the operator at the display allowing it.	An auxiliary display with priority 2 will immediately hand over control to another auxiliary display with priority 1. If control is handed over to an auxiliary display with priority 2, this is due to the operator at the display allowing it.	An auxiliary display with priority 3 hands over control directly to auxiliary displays with priority 1 and 2.

Lock

Once the administrator password has been entered, the administration section is unlocked for 1 hour. Press *Lock* if you want to lock the administration section immediately.

System Voltage

The system voltage should always be set to 24 V. Otherwise an alarm for incorrect voltage is activated.

Reset to Factory Defaults

Reset the auxiliary display to factory settings.



Examples of connection of sensors and monitors

Connection of 4-20 mA, e.g. oil pressure sensor for the reverse gear

In this example, an oil pressure sensor for reverse gear is connected, but connection works in the same way no matter what is to be measured.

1. Connect the sensor to one of the 4-20 mA inputs on the rear of the main display.

2. Connect the main display to a computer and go to the configuration interface.
3. Go to *i/o configuration > 4-20 mA* and select one of the inputs.
4. Click *assign custom name*. Select one language or more and give a name to the signal.
5. Configure the signal. Note that reverse gear oil pressure cannot be combined with conditions from another input (e.g. gear engaged), but conditions can be set regarding engine speed. See the example. *Channel Use* must be on *DCU+RP* for the signal to be shown on all displays.

More information is available in the [4-20 mA](#) section.

Contact the reverse gear manufacturer for alarm limits.

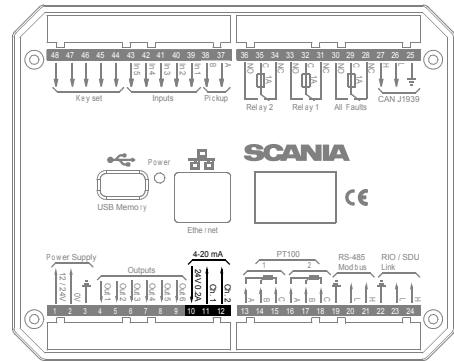

Connection to the main display.

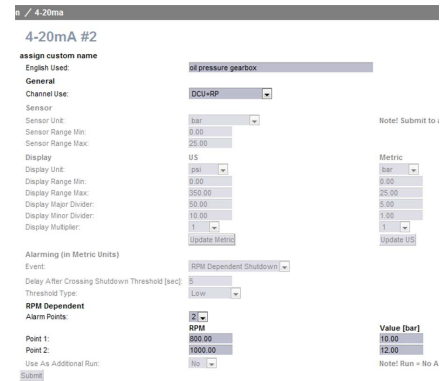



INSTALLATION MANUAL

Examples of connection of sensors and monitors

6. Add the signal to one of the instrument pages via *interface design > Pages*. In this example, we have chosen to add the signal to *Slot 4* on instrument page 1, which has *Template 14*. It is also possible to add the signal to a new instrument page by clicking *Insert Page* and then selecting a *Template* for it.

More information is available in the [Pages](#) section.

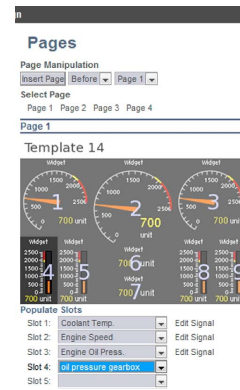

7. This is what the signal looks like on the fully-configured instrument page in the main display.

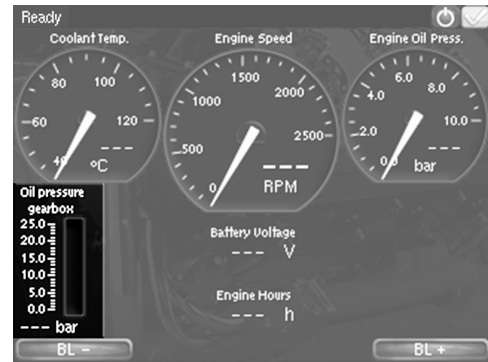

388 405

372 536



Connection of PT100, e.g. coolant temperature sensor

In this example a coolant temperature sensor is connected, but connection works the same way no matter what is to be measured.

1. Connect the sensor (which must be a PT100 sensor) to one of the two PT100 inputs on the rear of the main display.
- 2 wire PT100: Bridge A and B. Connect one wire to AB and the other to C.
- 3 wire PT100: Connect A to A, B to B and C to C.
- 4 wire PT100: Connect in the same way as 3 wire PT100, but note that the fourth wire, D, should not be connected. It should hang loose or, if necessary, be cut off.

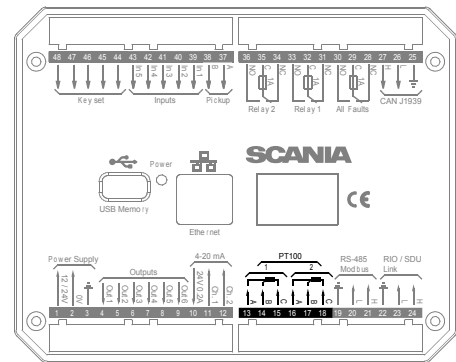

Connection to the main display.

2. Connect the main display to a computer and go to the configuration interface.
 3. Go to *i/o configuration > PT100* and select one of the inputs.
 4. Click *assign custom name*. Select one language or more and give a name to the signal.
 5. Configure the signal. *Channel Use* must be on *DCU+RP* for the signal to be shown on all displays.
- More information is available in the [PT100](#) section.

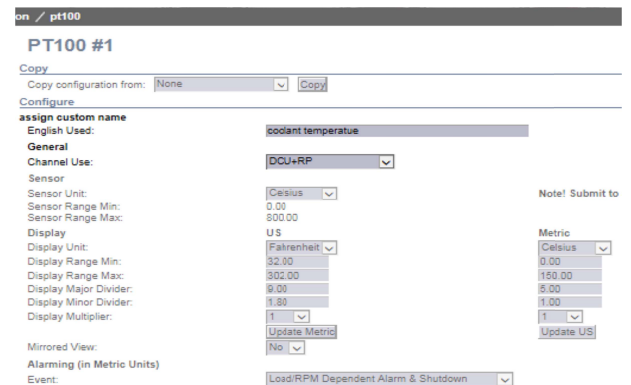



INSTALLATION MANUAL

Examples of connection of sensors and monitors

6. Add the signal to one of the instrument pages via *interface design > Pages*. In this example, we have chosen to add the signal to *Slot 1* on instrument page 2, which has *Template 8*. It is also possible to add the signal to a new instrument page by clicking *Insert Page* and then selecting a *Template* for it.

More information is available in the [Pages](#) section.



7. This is what the signal looks like on the fully-configured instrument page in the main display.

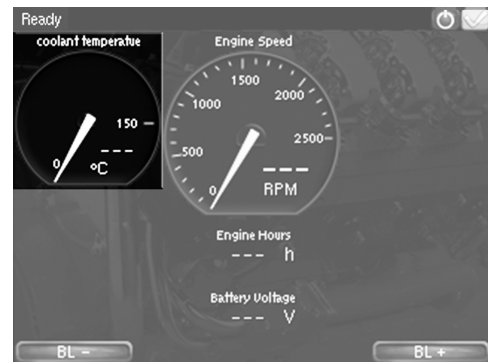



Connection of switch input, e.g. low engine oil pressure monitor

In this example a low engine oil pressure monitor is connected, but connection works the same way no matter what is to be monitored.

1. Connect the sensor to one of the Inputs on the rear of the main display.

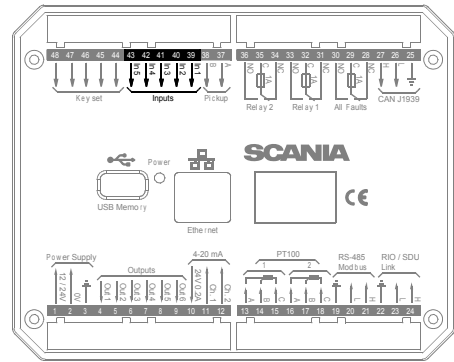

Connection to the main display.

2. Connect the main display to a computer and go to the configuration interface.
3. Go to *i/o configuration > switch* and select one of the inputs.
4. Click *assign custom name*. Select one language or more and give a name to the signal.
5. Configure the signal. More information is available in the [Switch](#) section.

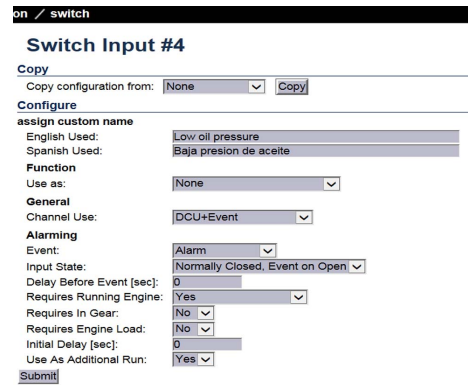



INSTALLATION MANUAL

Examples of connection of sensors and monitors

6. Add the signal to one of the instrument pages via *interface design > Pages*. In the example, a new instrument page has been added (*Page 5*) by clicking *Insert Page* and then selecting *Template 4* for it. The signal has been added to *Slot 5* on the instrument page.

More information is available in the [Pages](#) section.



7. This is what the signal looks like on the fully-configured instrument page in the main display.

