

Discard previous Service Bulletin 175-09 from 8.05.  
Changes are marked with a bar (|) in the margin.

Date	Group	No.	Release	Page
12.05	<b>175</b>	<b>09</b>	<b>18</b>	1(47)

Lubrication service and oil changes  
FM, FH, NH, FL, NL

## Lubrication service and oil changes

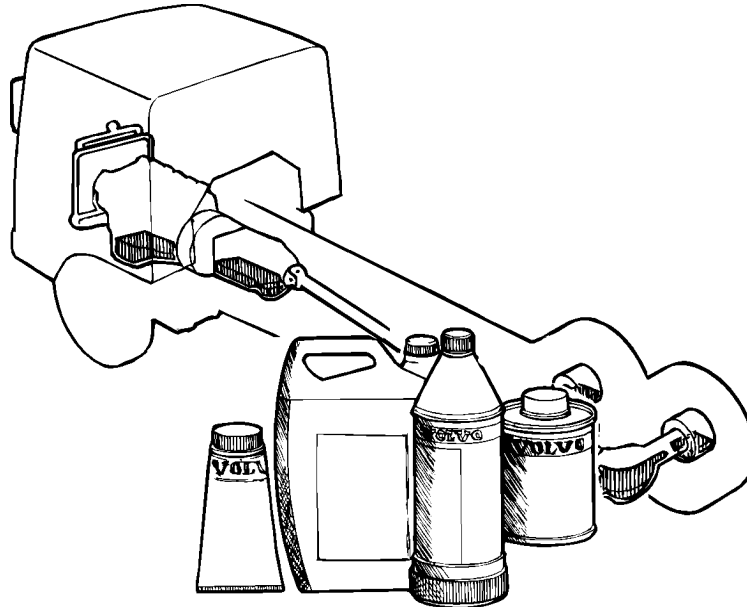

T1006282

### This service bulletin contains information on:

- Service intervals
- Oil and fluid volumes
- Oil grade and viscosity
- Filters and filter inserts
- Charge regulator
- Chassis lubrication, cab lubrication and grease quality
- Drive belts (multiple grooved belts)
- Air drier

**Note:** For service intervals for South America, see Service Bulletin 175 48

**Note:** For service intervals for the USA, please refer to Service Bulletins 175 001, 175 60 and 175 61.

# **Lubrication service and oil changes**

## **Contents**

### **“Engine” page 3**

- “Definitions” page 3
- “Oil change volumes” page 6
- “Oil filter” page 6
- “Engine oil, change intervals” page 7
- “Fuel filter change” page 18
- “Filter for fuel tank ventilation” page 18
- “Filter insert, air cleaner” page 18
- “Particulate filter, CRT” page 18
- “Mechanical compressor” page 18
- “Coolant” page 19
- “Drive belts” page 20
- “Valves and unit injectors, adjustment” page 20

### **“Gas engine” page 20**

### **“Charge regulator” page 21**

### **“Clutch” page 21**

### **“Gearbox” page 21**

- “1a. Volvo manufactured manual gearboxes” page 21
- “1b. ZF manufactured manual gearboxes” page 25
- “1c. Eaton manufactured manual gearboxes” page 26
- “2a. Volvo manufactured automatic transmissions” page 27
- “2b. Allison manufactured automatic transmissions” page 27

### **“Rear axle” page 29**

- “1a. Heavy rear axles” page 29
- “1b. Light rear axles.” page 32
- “1c. Other rear axles” page 33

### **“Driving front axle” page 34**

### **“Transfer case” page 35**

### **“Power take off (flywheel fitted)” page 37**

### **“Hydraulic retarder” page 38**

### **“Propeller shaft lubrication” page 39**

### **“Power steering, Steerable pusher axle, Bogie lift, Hub, Cab tilt pump” page 41**

### **“Brakes” page 41**

### **“Chassis lubrication” page 41**

### **“Cab” page 44**

### **“Volvo oils and fluids” page 45**

# Engine

## Definitions

English terms have been used for some of the definitions that follow. This is international. Each term has, however an explanation in the language of the document.

## Emissions classes

- Euro 1 corresponds to EC93
- Euro 2 corresponds to EC96, ECPT5 and ECPT6
- Euro 3 corresponds to EC99, EC01 and ECPT4

## Transport cycle

Typical construction site superstructure? <sup>1</sup> ?		
Yes	No	
Construction sites	Average distance between loading and unloading > 50 km <b>and</b> < 20% driving in a city environment <b>and</b> annual mileage >100000 km?	
	No	Yes
	Distribution	Long distance driving

<sup>1</sup> Includes timber trucks, tippers, dumpers, load exchangers, concrete mixers, waste compressors and special vehicles.

## Engine Operating Conditions (EOC)

the engine operating conditions (EOC) describe the degree of engine load.

The different load levels are:

- Light (L)
- Medium (M)
- Heavy (H)

- Severe (S)
- Very severe (VS)
- Very severe+ (VS+)

The abbreviations named above are used in the EOC table.

## Gross weight

**Gross weight** = Technical/Legal gross weight (combination) ton

## Topography

### Flat (F)

Uphill and downhill stretches with:

- gradients >3% for up to 1% of total mileage.
- Maximum gradients 8%.



T1008466

**Predominantly flat (PF)**

Uphill and downhill stretches with:

- gradients >3% for up to 20% of total mileage.
- gradients >6% for up to 1% of total mileage.
- Maximum gradients 16%.



T1008403

**Hilly (H)**

Uphill and downhill stretches with:

- gradients >3% for up to 35% of total mileage.
- gradients >6% for up to 10% of total mileage.
- gradients >9% for up to 1% of total mileage.
- Maximum gradients 20%.

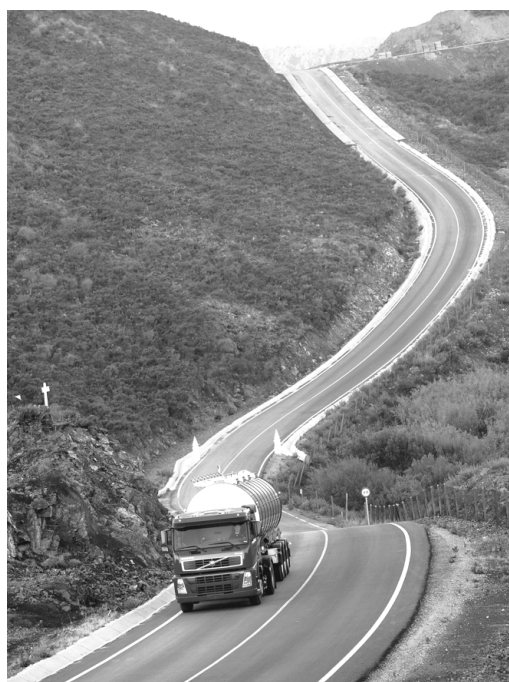

T1008404

**Very Hilly (VH)**

Typically mines, building sites etc



T9008082

Abbreviations in brackets are used in the EOC table.

## Warranty

The warranty is not valid if Volvo Truck Corporation can show that it is likely that the material defects or incorrect operation, for which the warranty has been invoked, is the result of:

- The vehicle not being driven in accordance with the applicable Volvo Truck Corporation instructions, e.g. that the stipulated warranty, basic or full servicing has not been carried out at the correct time and/or running hours interval (a service that has not been registered by Volvo Truck Corporation or recorded in this booklet is considered not to have been performed, unless absolute proof can be shown).
- Other parts than original parts from Volvo Truck Corporation have been used.
- Other oils, greases or coolant fluids than those recommended by Volvo Truck Corporation have been used.

**The above text is only an extract from the Warranty booklet. Refer to the Warranty booklet for complete warranty terms, conditions and requirements.**

## Oil grade

VDS, VDS-2, VDS-3

alternatively API CF, CF-4, CG-4, CH-4, CI-4

or ACEA E2, E3, E4, E5

Note that a combination of several of the above named qualities is required in some cases.

**Note:** Extra oil additives are not to be used. This includes engine and metal treatment additives added to the engine oil.

## Viscosity

The viscosity is selected in accordance with the table. Temperature values refer to constant air temperatures.

1) Only VDS-2 or VDS-3 oils.

When using 10W/30, fuel consumption can be lower than when using 15W/40. Note however the temperature interval recommended for 10W/30.

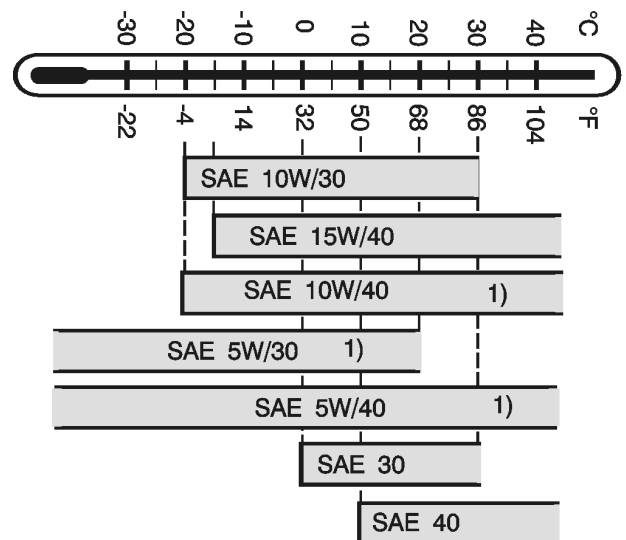

## Oil change volumes

Engine type	Oil change volume in litres, incl. approx. volume for oil filter.	Oil volume in litres between dipstick Max-Min
D4	12	3,8
TD61, TD63	17	5
D6A, D6B	19,5	5
G6A	17	5
G6B	19,5	6,5
TD71, TD73, D7A, D7B	20,5	6,5
D7C	19,5	6,5
D9A	28	6
D9A OILS-ST	33	5
TD102, TD103, D10A, D10B	34,5	10
TD122, TD123	36,5	12
D12A	36	8
D12A, FL	36	6
D12C, D12D OILS-PL, D12F OILS-PL, D12D OILS-ST	33	8
D12D OILS-STR	38	6
D12C, D12D; construction site vehicle	38	6
D13A OILS-PL	33	8
D13A OILS-ST	37	6
TD162, TD163	47	15
D16A D16B	42	10
D16C	42	9

## Oil filter

The by-pass and full flow filter should be replaced at each oil change.

Use only Volvo original oil filters.

## Engine oil, change intervals

Service intervals:

**First oil and filter change** is at the warranty service after 10,000 km or 4 weeks, whichever occurs first. Except all vehicles manufactured in Europe.

### *Limits to the tables on the following pages*

- Definition of "Other oil grade" on the following pages: Oils which meet at least one of the following ACEA E2, E3, E4, E5; API CF, CF-4, CG-4, CH-4, CI-4.
- **D13A engine:**
  - Oil change intervals for the D13A engine must not exceed 12 months.
  - If the sulphur content in the fuel exceeds 0.05 per cent by weight, the oil change interval should be reduced to 2/3 taking into account the distance driven, engine running hours and calendar time.
  - If the sulphur content in the fuel exceeds 0.5 per cent by weight, the oil change interval should be reduced to 1/3 taking into account the distance driven, engine running hours and calendar time.

**Note:** These sulphur level limitations and oil change intervals can also be applied for other engines, although this is not mandatory.

This applies irrespective of mileage, engine hours, calendar period or amount of fuel consumed. Fuels with extremely low sulphur content, such as environmentally classed fuels, do **not** permit the service interval to be extended.

- **Other engines:**

No oil change interval is allowed to exceed 6 months.

If the sulphur content in the fuel exceeds 0.5 percentage by weight, the oil change interval should be halved.

This applies irrespective of mileage, engine hours, calendar period or amount of fuel consumed. Fuels with extremely low sulphur content, such as environmentally classed fuels, do **not** permit the service interval to be extended.

- Full flow filter, longlife, with part number 478736 should be used if the oil change interval exceeds 30,000 km. All 16 litre engines must use filter 478736 irrespective of oil change interval.

### *Interval tables*

"TD61 TD63 TD71 TD73" page 8

"TD102, TD122, TD162" page 8

"TD103, TD123, TD163" page 8

"D4 D6A D7 D10 D12A D12C D16A D16B" page 8

"D6B Euro 2/Euro 3, D7C Euro 3" page 9

"D9A" page 12

"D12D Euro2/Euro3" page 13

"D12F EM JPN04" page 14

"D13A Euro3" page 16

"D16C Euro3" page 17

### TD61 TD63 TD71 TD73

Engine type	Oil grade	Max mileage in km						Max period, months
		15 000	20 000	25 000	30 000	40 000	45 000	
TD61, TD63, TD71, TD73	VDS-2/3			X				6
	VDS			X				
	Other oil grade	X						

### TD102, TD122, TD162

Engine type	Oil grade	Max mileage in km						Max period, months
		15 000	20 000	25 000	30 000	40 000	45 000	
TD102, TD122, TD162	VDS-2/3					X		6
	VDS					X		
	Other oil grade	X						

### TD103, TD123, TD163

Engine type	Oil grade	Max mileage in km						Max period, months
		15 000	20 000	25 000	30 000	40 000	45 000	
TD103, TD123, TD163	VDS-2/3					X		6
	VDS				X			
	Other oil grade	X						

### D4 D6A D7 D10 D12A D12C D16A D16B

Engine type		D4, D6A, D7A/B	D7C Eu2 (FM)	D10, D12 (FL)	
Transport cycle		-	-	Long distance driving	Other
VDS-3/ VDS-2	Mileage, max (km)	25 000	40 000	-	40 000
	Fuel consumed, max (litres) <sup>1</sup>	-	10 000	20 000	20 000
VDS	Mileage, max (km) <sup>1</sup>	20 000	20 000	30 000	30 000
	Fuel consumed, max (litres) <sup>1</sup>	-	5 000	13 000	13 000
Other oil grade	Mileage, max (km) <sup>1</sup>	15 000	15 000	15 000	15 000
	Fuel consumed, max (litres) <sup>1</sup>	-	4 000	7 000	7 000

<sup>1</sup> Whichever occurs first



Engine type		D12A Eu1 (FH)		D12A/C Eu2/Eu3 (FM, FH, NH)		D16A, D16B	
Transport cycle		Long distance driving	Other	Long distance driving	Other	Long distance driving	Other
VDS-3/ VDS-2	Mileage, max (km)	-	45 000	-	45 000	-	40 000
	Fuel consumed, max (litres) <sup>1</sup>	20 000	20 000	20 000 <sup>2</sup>	20 000	20 000	20 000
VDS	Mileage, max (km) <sup>1</sup>	45 000	45 000	30 000	30 000	30 000 <sup>3</sup>	30 000 <sup>3</sup>
	Fuel consumed, max (litres) <sup>1</sup>	13 000	13 000	13 000	13 000	13 000	13 000
Other oil grade	Mileage, max (km) <sup>1</sup>	15 000	15 000	15 000	15 000	15 000	15 000
	Fuel consumed, max (litres) <sup>1</sup>	7 000	7 000	7 000	7 000	7 000	7 000

<sup>1</sup> Whichever occurs first

<sup>2</sup> D12C Eu2 (EC96), GCW<44 t: 25,000 litres

<sup>3</sup> D16A Eu1 (EC93): 40,000 km

## D6B Euro 2/Euro 3, D7C Euro 3

The following is a step by step description of how to read the tables below.

1. Go to row "Gross weight, combination" and select an appropriate column.
2. Go to the next row in the selected column. This column can in turn be divided into several columns depending on the fuel consumption of the truck in question.
3. Select the column which corresponds to the average fuel consumption for the vehicle.
4. This column will contain the values for the three oil qualities. Select the grade which is to be used and read off the "Mileage" and "Fuel consumed", select the value which occurs first.

### D6B Euro 2/Euro 3

Gross weight, combination		Less than 15 000 kg		
Fuel consumption, average		Less than or equal to 25 litres/100 km	Less than or equal to 30 litres/100 km	More than 30 litres/100 km
Oil grade VDS-3	Mileage, max (km) <sup>1</sup>	40 000	32 000	25 000
	Fuel consumed, max (litres) <sup>1</sup>	-	8 000	8 000
Oil grade VDS-2 or VDS plus ACEA E3 <sup>2</sup>	Mileage, max (km) <sup>1</sup>	30 000	25 000	20 000
	Fuel consumed, max (litres) <sup>1</sup>	-	6 000	6 000
VDS or Other oil grade	Mileage, max (km) <sup>1</sup>	15 000	15 000	15 000
	Fuel consumed, max (litres) <sup>1</sup>	4 000	4 000	4 000

<sup>1</sup> Whichever occurs first

<sup>2</sup> Note that the oil grade must comply with both VDS and ACEA E3

Gross weight, combination		Less than 19,000 kg		More than 19,000 kg
Fuel consumption, average		Less than or equal to 30 litres/100 km	More than 30 litres/100 km	Independent of fuel consumption
Oil grade VDS-3	Mileage, max (km) <sup>1</sup>	40 000	25 000	25 000
	Fuel consumed, max (litres) <sup>1</sup>	8 000	8 000	8 000

Gross weight, combination		Less than 19,000 kg		More than 19,000 kg
Fuel consumption, average		Less than or equal to 30 litres/100 km	More than 30 litres/100 km	Independent of fuel consumption
Oil grade VDS-2 or VDS plus ACEA E3 <sup>2</sup>	Mileage, max (km) <sup>1</sup>	30 000	20 000	20 000
	Fuel consumed, max (litres) <sup>1</sup>	6 000	6 000	6 000
VDS or Other oil grade	Mileage, max (km) <sup>1</sup>	15 000	15 000	15 000
	Fuel consumed, max (litres) <sup>1</sup>	4 000	4 000	4 000

<sup>1</sup> Whichever occurs first

<sup>2</sup> Note that the oil grade must comply with both VDS and ACEA E3

**D7C Euro 3**

Gross weight, combination		Less than 18,000 kg		
Fuel consumption, average		Less than or equal to 25 litres/100 km	Less than or equal to 30 litres/100 km	More than 30 litres/100 km
Oil grade VDS-3	Mileage, max (km) <sup>1</sup>	40 000	32 000	25 000
	Fuel consumed, max (litres) <sup>1</sup>	-	8 000	8 000
Oil grade VDS-2 or VDS plus ACEA E3 <sup>2</sup>	Mileage, max (km) <sup>1</sup>	30 000	25 000	20 000
	Fuel consumed, max (litres) <sup>1</sup>	-	6 000	6 000
VDS or Other oil grade	Mileage, max (km) <sup>1</sup>	15 000	15 000	15 000
	Fuel consumed, max (litres) <sup>1</sup>	4 000	4 000	4 000

<sup>1</sup> Whichever occurs first

<sup>2</sup> Note that the oil grade must comply with both VDS and ACEA E3

Gross weight, combination		Less than 26,000 kg		More than 26,000 kg
Fuel consumption, average		Less than or equal to 30 litres/100 km	More than 30 litres/100 km	Independent of fuel consumption
Oil grade VDS-3	Mileage, max (km) <sup>1</sup>	40 000	25 000	25 000
	Fuel consumed, max (litres) <sup>1</sup>	8 000	8 000	8 000
Oil grade VDS-2 or VDS plus ACEA E3 <sup>2</sup>	Mileage, max (km) <sup>1</sup>	30 000	20 000	20 000
	Fuel consumed, max (litres) <sup>1</sup>	6 000	6 000	6 000
VDS or Other oil grade	Mileage, max (km) <sup>1</sup>	15 000	15 000	15 000
	Fuel consumed, max (litres) <sup>1</sup>	4 000	4 000	4 000

<sup>1</sup> Whichever occurs first

<sup>2</sup> Note that the oil grade must comply with both VDS and ACEA E3

## D9A

For definitions and abbreviations see "Definitions" page 3.

### Engine Operating Conditions (EOC)

Transport cycle	Long distance driving					Distribution regional			Distribution town		Construction sites <sup>1</sup>		
	≤44			45-65		≤29	30-44	45-65	≤29	≥30	≤44	≥45	
To-pography	F	PF	H	F	H						H	H	VH
EOC	M <sup>2</sup>	M <sup>2</sup>	H	H	S	M <sup>2</sup>	H	S	S	VS	S	VS	VS+

<sup>1</sup> Includes timber trucks, tippers, dumpers, load exchangers, concrete mixers, waste compressors and special vehicles.

<sup>2</sup> Only 4x2/6x2, without power take off, max 90 kph

### Oil change interval

EOC	M	H	S	VS	VS+
Maximum permitted fuel consumption (l/100 km)	≤ 35	≤ 44	≤ 57	≤ 100	-
Mileage (km) / time (hours) NB! No oil change interval is allowed to exceed 6 months.					
Oil grade VDS-3	60000/-	45000/600	30000/400	15000/400 <sup>1</sup>	-/400 <sup>1</sup>
Oil grade VDS-2	40000/-	30000/400	20000/300	10000/300 <sup>2</sup>	-/300 <sup>2</sup>
Oil grade VDS / Other oil grade	20000/-	15000/200	10000/150	5000/150 <sup>3</sup>	-/150 <sup>3</sup>
For waste collection, mine operation, airport service etc, engine hours (hours) can be used instead.					

<sup>1</sup> Maximum permitted fuel consumption 15 000 litres (37.5 litres/hour).

<sup>2</sup> Maximum permitted fuel consumption 10 000 litres (33.3 litres/hour).

<sup>3</sup> Maximum permitted fuel consumption 5 000 litres (33.3 litres/hour).

### Preventive maintenance

EOC	M	H	S	VS	VS+
	km/max. months				H/max. months
Full service	- / 12				
Basic service	60000/6 <sup>1</sup>	45000/6 <sup>1</sup>	30000/6 <sup>1</sup>	15000/6 <sup>1</sup>	400/6 <sup>1</sup>

<sup>1</sup> Whichever occurs first.

### Valves and unit injectors, adjustment

EOC	M	H	S	VS	VS+
Interval	200,000 km or every 12 months, whichever occurs first <sup>1</sup>			100,000 km or every 6 months, whichever occurs first	
<sup>1</sup> The service interval shall be halved in the case of frequent driving at more than 90km/h					

## D12D Euro2/Euro3

For definitions and abbreviations see "Definitions" page 3.

### Engine Operating Conditions (EOC)

Transport cycle	Long distance driving						Distribution, regional			Distribution, Town		Construction sites <sup>1</sup>		
	≤ 44			45 - 68		≥ 69	≤ 44	45 - 68	≥ 69	≤ 32	≥ 33	≤ 68	≥ 69	
To-pography	F	PF	H	F	H							H	H	VH
EOC	L <sup>2</sup>	M <sup>3</sup>	H	H	S	VS	H	S	VS	S	VS	S	VS	VS+

<sup>1</sup> Includes timber trucks, tippers, dumpers, load exchangers, concrete mixers, waste compressors and special vehicles.

<sup>2</sup> Only 4x2/6x2, without power take off, max 90 kph, D12DEuro3, Europe

<sup>3</sup> Only 4x2/6x2, without power take off, max 90 kph

### Oil change interval

EOC	L	M	H	S	VS	VS +
Maximum permitted fuel consumption (l/100 km)	≤ 33	≤ 39	≤ 46	≤ 59	≤ 120	-
Mileage (km) / time (hours) NB! No oil change interval is allowed to exceed 6 months.						
Oil grade VDS-3	90000 <sup>1</sup> /-	75000/-	60000/750	45000/600	20000/600 <sup>2</sup>	-/600 <sup>2</sup>
Oil grade VDS-2	60000/-	50000/-	40000/500	30000/400	15000/400 <sup>3</sup>	-/400 <sup>3</sup>
Oil grade VDS / Other oil grades	30000/-	25000/-	20000/250	15000/200	10000/200 <sup>4</sup>	-/200 <sup>4</sup>
For waste collection, mine operation, airport service etc, engine hours (hours) can be used instead.						

<sup>1</sup> Can be extended to 100,000 km if gross weight never exceeds 36 tons with other conditions unchanged and VDS-3 oil used.

<sup>2</sup> Maximum permitted fuel consumption 25 000 litres (41.7 litres/hour).

<sup>3</sup> Maximum permitted fuel consumption 16 000 litres (40 litres/hour).

<sup>4</sup> Maximum permitted fuel consumption 8 000 litres (40 litres/hour).

### Preventive maintenance

EOC	L	M	H	S	VS	VS+
	km/max. months					H/max. months
Full service	—/12					
Basic service	90000/6 <sup>1</sup>	75000/6 <sup>1</sup>	60000/6 <sup>1</sup>	45000/6 <sup>1</sup>	20000/6 <sup>1</sup>	600/6 <sup>1</sup>

<sup>1</sup> Whichever occurs first.

### Valves and unit injectors, adjustment

EOC	M	H	S	VS	VS+
Interval D12D 340-460	400,000 km or every 24 months, whichever occurs first <sup>1</sup>			200,000 km or every 12 months, whichever occurs first	
Interval D12D 500	200,000 km or every 12 months, whichever occurs first <sup>1</sup>			100,000 km or every 6 months, whichever occurs first	
<sup>1</sup> The service interval shall be halved in the case of frequent driving at more than 90km/h					

## D12F EM JPN04

For definitions and abbreviations see "Definitions" page 3.

### Engine Operating Conditions (EOC)

Transport cycle	Long distance driving					Distribution, regional			Distribution, Town			Construction sites <sup>1</sup>			
	GCW	≤ 44	45 - 68	≥ 69	≤ 32	32-44	45-68	≤ 32	32-44	≤ 44	≤ 32	33-44	45-68		
To-pog-raphy	PF	H	PF	H							H	H	H	VH	
EOC	M <sup>2</sup>		H <sup>3</sup>	S <sup>3</sup>	VS <sup>3</sup>	M	H	S	S	VS	VS	H	S	VS	VS+

<sup>1</sup> Includes timber trucks, tippers, dumpers, load exchangers, concrete mixers, waste compressors and special vehicles.

<sup>2</sup> Only 4x2/6x2, without power take off, max 90 kph

<sup>3</sup> Max. 90 km/h

### Oil change interval

EOC	M	H	S	VS	VS+
Maximum permitted fuel consumption (l/100km)	≤ 39	≤ 50	≤ 64	≤ 120	-
Mileage (km) / time (hours) NB! No oil change interval is allowed to exceed 6 months.					
Oil grade VDS-3 <sup>1</sup>	50000/650	40000/500	30000/400	15000/400 <sup>2</sup>	-/400 <sup>2</sup>
Oil grade VDS-2	35000/450	25000/350	20000/300	10000/300 <sup>3</sup>	-/300 <sup>3</sup>
Oil grade VDS / Other oil grades	20000/300	15000/250	10000/200	7500/200 <sup>4</sup>	-/200 <sup>4</sup>
For waste collection, mine operation, airport service etc, engine hours (hours) can be used instead.					

<sup>1</sup> D12 F can be fitted with DPF-filter. In this case VDS-3 LSA quality oil must be used. VDS-3 LSA is VDS-3 oil with low sulphate content, max 1.1%. The same interval as for VDS-3 oils applies, as shown in the above table.

<sup>2</sup> Maximum permitted fuel consumption 15 000 litres (37.5 litres/hour).

<sup>3</sup> Maximum permitted fuel consumption 12 000 litres (40 litres/hour).

<sup>4</sup> Maximum permitted fuel consumption 8 000 litres (40 litres/hour).

### Preventive maintenance

EOC	M	H	S	VS	VS+
	km/max. months				H/max. months
Full service	- / 12				
Basic service	50000/6 <sup>1</sup>	40000/6 <sup>1</sup>	30000/6 <sup>1</sup>	15000/6 <sup>1</sup>	400/6 <sup>1</sup>

<sup>1</sup> Whichever occurs first.

### Valves and unit injectors, adjustment

EOC	M	H	S	VS	VS+
Interval D12F 390-500	200,000 km or every 12 months, whichever occurs first <sup>1</sup>			100,000 km or every 6 months, whichever occurs first	
<sup>1</sup> The service interval shall be halved in the case of frequent driving at more than 90km/h					

### EGR pipe, clean

Service interval	200,000 km or every 24 months, whichever occurs first
------------------	---

*Particulate filter, DPF, clean*

Service interval	Every 12 months
------------------	-----------------

## D13A Euro3

For definitions and abbreviations see "Definitions" page 3.

### Engine Operating Conditions (EOC)

Transport cycle	Long distance driving					Distribution				Construction sites <sup>1</sup>			
						Regional			Town				
GCW	≤ 44		45 - 68		≥ 69	≤ 32	33-44	45-68	≤ 32	≤ 32	33-44	45-68	
Topography	PF	H	PF	H						H	H	H	VH
EOC	L <sup>2</sup>	M <sup>3</sup>	H <sup>3</sup>	S <sup>3</sup>	VS <sup>3</sup>	M	H	S	S	H	S	VS	VS+

<sup>1</sup> Includes timber trucks, tippers, dumpers, load exchangers, concrete mixers, waste compressors and special vehicles.

<sup>2</sup> Max. 90 km/h, without power take-off.

<sup>3</sup> Max. 90 km/h

### Oil change interval

EOC	L	M	H	S	VS	VS+
Maximum permitted fuel consumption (l/100 km)	≤ 33	≤ 39	≤ 50	≤ 64	≤ 120	-
Mileage (km)/time (hours) NB! No oil change interval is allowed to exceed 12 months.						
Oil grade VDS-3	100000/-	75000/-	60000/750	45000/600	20000/600 <sup>1</sup>	-/600 <sup>1</sup>
Oil grade VDS-2	60000/-	50000/-	40000/500	30000/400	15000/400 <sup>2</sup>	-/400 <sup>2</sup>
Oil grade VDS / Other oil grades	30000/-	25000/-	20000/250	15000/200	10000/200 <sup>3</sup>	-/200 <sup>3</sup>
For waste collection, mine operation, airport service etc, engine hours (hours) can be used instead.						

<sup>1</sup> Maximum permitted fuel consumption 25 000 litres (41.7 litres/hour).

<sup>2</sup> Maximum permitted fuel consumption 16 000 litres (40 litres/hour).

<sup>3</sup> Maximum permitted fuel consumption 8 000 litres (40 litres/hour).

### Preventive maintenance

EOC	L	M	H	S	VS	VS+
	km/max. months					H/max. months
Full service	—/12					
Basic service	100000/6 <sup>1</sup>	75000/6 <sup>1</sup>	60000/6 <sup>1</sup>	45000/6 <sup>1</sup>	20000/6 <sup>1</sup>	400/6 <sup>1</sup>

<sup>1</sup> Whichever occurs first.

### Valves and unit injectors, adjustment

EOC	M	H	S	VS	VS+
Interval D13A 400-480	400,000 km or every 24 months, whichever occurs first <sup>1</sup>			200,000 km or every 12 months, whichever occurs first	
Interval D13A 520	200,000 km or every 12 months, whichever occurs first <sup>1</sup>			100,000 km or every 6 months, whichever occurs first	

<sup>1</sup> The service interval shall be halved in the case of frequent driving at more than 90km/h



## D16C Euro3

For definitions and abbreviations see "Definitions" page 3.

### Engine Operating Conditions (EOC)

Trans- port cycle	Long distance driving							Distribution			Construction sites <sup>1</sup>		
	≤ 44			45 - 68			> 68	≤ 44	45 - 68	> 68	≤68	> 68	
GCW													
To- pog- raphy	F	PF	H	F	PF	H					H	H	VH
EOC	L <sup>2</sup>	M <sup>2</sup>	M <sup>2</sup>	M <sup>2</sup>	H	S	VS	H	S	VS	S	VS	VS +

<sup>1</sup> Includes timber trucks, tippers, dumpers, load exchangers, concrete mixers, waste compressors and special vehicles.

<sup>2</sup> Without power take off, max 90 kph

### Oil change interval

EOC	L	M	H	S	VS	VS+
Maximum permitted fuel consumption (l/100 km)	≤ 36	≤ 44	≤ 53	≤ 69	≤ 140	-
Mileage (km) / time (hours) NB! No oil change interval is allowed to exceed 6 months.						
Oil grade VDS-3	90000 <sup>1</sup> /-	75000/-	60000/750	45000/600	20000/600 <sup>2</sup>	-/600 <sup>2</sup>
Oil grade VDS-2	60000/-	50000/-	40000/500	30000/400	15000/400 <sup>3</sup>	-/400 <sup>3</sup>
Oil grade VDS / Other oil grade	30000/-	25000/-	20000/250	15000/200	10000/200 <sup>4</sup>	-/200 <sup>4</sup>
For waste collection, mine operation, airport service etc, engine hours (hours) can be used instead.						

<sup>1</sup> Can be extended to 100,000 km if gross weight never exceeds 36 tons with other conditions unchanged and VDS-3 oil used.

<sup>2</sup> Maximum permitted fuel consumption 25 000 litres (41.7 litres/hour).

<sup>3</sup> Maximum permitted fuel consumption 16 000 litres (40 litres/hour).

<sup>4</sup> Maximum permitted fuel consumption 8 000 litres (40 litres/hour).

### Preventive maintenance

EOC	L	M	H	S	VS	VS+
	km/max. months					H/max. months
Full service	—/12					
Basic service	90000/6 <sup>1</sup>	75000/6 <sup>1</sup>	60000/6 <sup>1</sup>	45000/6 <sup>1</sup>	20000/6 <sup>1</sup>	600/6 <sup>1</sup>

<sup>1</sup> Whichever occurs first.

### Valves and unit injectors, adjustment

EOC	M	H	S	VS	VS+
Interval	200,000 km or every 12 months, whichever occurs first <sup>1</sup>			100,000 km or every 6 months, whichever occurs first	
<sup>1</sup> The service interval shall be halved in the case of frequent driving at more than 90km/h					

## Fuel filter change

D4, D6B, D9A, D12D, D13A, D16C .....	at each oil change.
TD61/63, D6A, TD71/73, D7A, D7B .....	every 12 months.
Other engines .....	every 6 months.
Water separator D9A, D12D, D13A, D16C .....	at each oil change.
Water separator other engines .....	every 6 months.

Under some conditions the fuel filter will need to be changed earlier, for example:

- low fuel pressure
- power reduction
- irregular fuel quality.

## Filter for fuel tank ventilation

This filter is installed on certain markets.

Change interval: every 24 months.

Under some conditions the filter will need to be changed earlier, for example:

- driving in dusty surroundings.

## Filter insert, air cleaner

Model	Changing the primary filter	Changing the secondary filter
FL/ FH/ NH/ FM	When the indicator light comes on, a symbol on the display is shown or the indicator shows, but at least each 24th month.	every 3rd change of the primary filter, or no later than every 48 months. The secondary filter should also be changed if the indicator light comes on, a symbol on the display is shown or the indicator shows, regardless of primary filter change.

## Particulate filter, CRT

Vehicle type	Cleaning interval
FM7, FL6	40,000 km or every 6 months, whichever occurs first
FM9	At each engine oil change

## Mechanical compressor

D6A250	Oil change volume	100 ml
	Oil grade	Special oil part no. 85108974
	Change interval	Oil change interval every 12 months.

## Coolant Volumes

Engine	Coolant volume (litres) <sup>1</sup>
D4	29
TD61	28
TD63, D6	30
G6A	30
G6B	27
TD71	31
TD73, D7A, D7B	32
D7C	40
D9A, FM9	37

Engine	Coolant volume (litres) <sup>1</sup>
TD102, TD103, D10	47
D10 FM10	47
TD122, TD123	50
TD162, TD163	58
D12 FH12, D13 FH	44
D12 FM12, D13 FM	42
D16	52

<sup>1</sup> Only a guideline, as this varies dependent on vehicle installation and equipment.

## Service intervals

	Change coolant	Change coolant filter	Other
Volvo Coolant <sup>1</sup> with coolant filter.	500,000 km or every 48 months.	100,000 km or every 6 months	When the coolant is changed <b>then</b> the coolant filter should also be changed.
Volvo Coolant <b>without</b> coolant filter.	250,000 km or every 24 months.		
Volvo Coolant VCS <sup>1, 2</sup>	500,000 km or every 48 months.	—	Volvo Coolant VCS shall <b>not</b> be used with coolant filters.
Volvo Anti-corrosion agent. <sup>2</sup> (Recommended only where Volvo coolant is not available in that market.)	100,000 km or every 12 months.	Every 6 months	When the oil is changed the cooling system is topped up with corrosion prevention fluid, 1 dl/10 l water.

<sup>1</sup> Note that Volvo Coolant and Volvo Coolant VCS shall not be mixed.

<sup>2</sup> Note that Volvo Coolant VCS and anti-corrosion agent shall not be mixed.

### Anti-freeze

**Note:** Mixing with other types of concentrated coolant can result in inferior anti-corrosive properties resulting in damage to the engine.

When the coolant is changed, the cooling system should be carefully flushed clean.

The adjacent table shows the approximate volume of concentrated coolant required for anti-freeze protection at the given temperature.

Protection against freezing down to:	Mixture of concentrated coolant
-25° C	40%
-30° C	46%
-38° C	54%
-46° C	60%

**Note:** -46° C is the minimum temperature below which freezing cannot be prevented. Increasing the amount of concentrated coolant beyond this decreases frost protection.

## Drive belts

### Service intervals

Multi-ribbed belts	Change interval
D6 with Multi-ribbed belt for the mechanical compressor (Supercharger)	150,000 km <sup>1</sup>
D7 with Multi-ribbed belts for alternator and cooling fan	300,000 km <sup>1</sup>
D10 with Multi-ribbed belts for alternator and cooling fan	400,000 km <sup>1</sup>
D9A, D12, D13, D16 with multi-ribbed belts for alternator and cooling fan	500,000 km <sup>1</sup>
PSS-DUAL, FH and FL with Multi-ribbed belt behind the gearbox to drive the servo pump for the extra power steering system (trucks with twin power steering systems)	100,000 km <sup>1</sup>

<sup>1</sup> However maximum 36 months. Applies to Volvo original drive belts.

### Valves and unit injectors, adjustment

Engine type	Interval
D12C Mark 3 labelled with C3	200,000 km or every 12 months, whichever occurs first <sup>1</sup>
D9A, D12D 500, D12D340–460, D13A, D16C	Refer to the information concerning service intervals applying to the respective engine types and oil change intervals, pages 5–12

<sup>1</sup> The service interval shall be halved in the case of frequent driving at more than 90km/h, or in the case of very severe engine operating conditions equivalent to EOC VS and VS+.

## Gas engine

Oil and filter change			
Engine type	Max mileage, km <sup>1</sup>	Max period, months <sup>1</sup>	Approved oils
G6A	30 000	12	<b>Volvo part.no. 85104226</b> , or BP Vanellus AF5 Castrol RX Super Gas Cepsa Ecogas ChevronTexaco Geotex VR multigrade Elf Lubrigas 7m FINA Ng motor oil HRD Maxima Gaz 7 Mobil Delvac Super GEO Mobil Pegasus 1 Q8 Mahler T Shell Rimula NX Slovnaft Madit Gas Super Statoil PowerWay GE Teboil Special GML TOTAL Rubia gas Viscosity: For all oils in this list 15W/40
G6B	40 000		

<sup>1</sup> whichever occurs first

## Spark plugs

Engine type	Spark plug type	Change interval
G6A	Champion RN 79 G	At each oil change
G6B		

## Charge regulator

Model	Change interval
FL/ FM/ FH/ NH	200,000 km

## Clutch

Oil grade . . . . . Brake fluid in accordance with the standard DOT 4 (SAE J 1703)

At extremely low temperatures, below -40°C, use brake fluid Volvo part no. 85104143. The brake fluid complies with DOT3. It has in addition been adapted to lower temperatures than DOT3 is specified for.

## Gearbox

Because of the differences between different gearbox manufacturer's **recommendations**, these recommendations are sub-divided as follows:

"1a. Volvo manufactured manual gearboxes" page 21

"1b. ZF manufactured manual gearboxes" page 25

"1c. Eaton manufactured manual gearboxes" page 26

"2a. Volvo manufactured automatic transmissions" page 27

"2b. Allison manufactured automatic transmissions" page 27

### 1a. Volvo manufactured manual gearboxes

#### Oil change volumes

Gearbox	Approx. change volume in litres	Gearbox	Approx. change volume in litres
AT2412C	16	SRO2000	11
AT2512C	16	SRO2400	11
ATO2512C	16	VT2014	13,5
R1000	9,5	VT2014OD	13,5
R1400	12	VT2514	13,5
R1500	11,5	VT2514OD	13,5
R1700	12	VT1708B	11,5
R1900	12	VT2009B	12
SR1400	13	VT2214B	13,5
SR1700	13	VT2412B	13
SR1700 with Geartronic	13,5	VT2514B	13,5
SR1900	13	VTO2214B	13,5
SR1900 with Geartronic	13,5	VTO2514B	13,5

Gearbox	Approx. change volume in litres	Gearbox	Approx. change volume in litres
SR2000	11	VT2814B	13,5
SR2400	11	VTO2814B	13,5

On gearboxes with transparent level plugs, the oil is to be filled up to the **max-marking** on the level plug (because the oil level will drop when the oil filter housing has been filled). When checking the oil level, it should be between the centre and max marking on the transparent level plug.

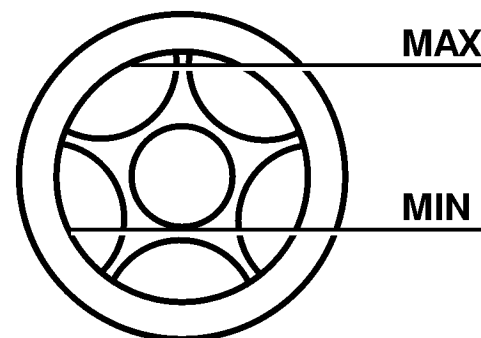

T1007661

On gearboxes without transparent level plug, the oil is to be filled up to the edge of the level hole.

If the gearbox has a rear power take off or an oil cooler, additional oil should be filled in accordance with the following table.

Component	Additional amounts of oil in litres
Single power take-off BKU/PTR	0,8
Double power take-off DBKU/PTRD	0,8
Oil cooler TC-MWO (Cool TW and T1, old designations)	0,1
Oil cooler TC-MWOH (Cool TWH and T1H, old designations)	0,8
Oil cooler TC-MAOH	0,8
Oil cooler TC-MWOH2	0,8
Oil cooler TC-MAOH2	0,8

### Service categories

For a number of reasons these gearboxes cannot have the same service recommendations. They have therefore been divided up into different service categories.

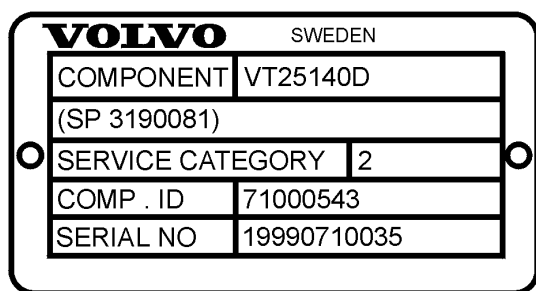

T1006942

The service categories, designated by a number or a letter, are indicated on **the rating plate** located on the gearbox. The categories are G, 1, 2, 3 and 4

**Note:** If the gearbox has **no** service category marked on **the rating plate**, it belongs to **category G**.

Two different service recommendations can be applied to the gearboxes:

- **Standard service recommendation**
- **Alternative service recommendation**

The alternative service recommendation provides longer service intervals than standard service recommendation. The alternative service recommendation requires the use of special oils. The limits in the table must however be observed.

Customers can always select the service recommendation they prefer after taking into consideration the relevant restrictions described in the following table.

Service category	Restrictions when using alternative service recommendation
G	<p>To use the alternative service recommendation on gearboxes R1000, R/SR1400, R/SR1700, R/SR1900, SR1700+ Geartronic and SR1900+ Geartronic, certain conditions must have been fulfilled:</p> <ul style="list-style-type: none"> <li>• The gearbox should be equipped with an improved oil filter guard. The improved oil filter guard was introduced into production in August 1996. The oil filter guard can be retrofitted to older gearboxes. The replacement oil filter guard is available in the spare parts kit with part number 3094780 for gearboxes without retarder and 3094781 for gearboxes with retarder.</li> <li>• It is not possible to fit the improved oil filter guard to the gearbox if the old type of oil cooler VXKYL7 (coil cooler) is used with gearboxes R1000, R/SR1400, R/SR1700, R/SR1900, SR1700+ Geartronic and SR1900+ Geartronic. In these cases, the alternative service recommendation cannot be used. It is, however, possible to replace the old type VXKYL7 with the new type VXKYL7 (donut). With the new type of VXKYL7, it is possible to fit the improved oil filter guard and in this way the alternative service recommendation can be used. In addition, the connection nipple in the spare part kits 3094780 or 3094781 must be replaced with part number 1671995. (The new type of VXKYL7 together with the improved oil filter guard is fitted in production on all gearboxes with oil coolers from August 1996. The new type of VXKYL7 is the same oil cooler as COOL T1.)</li> </ul>

The standard service recommendation and alternative service recommendation both consist of three parts. The three parts are **oil grade**, **viscosity** and **service intervals**. These are found in the same order on the following pages.

The following procedure can be very useful when deciding which oil to use.

- 1 Find out which service category the component belongs to.
- 2 Use the information in the table below **Service intervals** and determine which service recommendation should be used.
- 3 Use the information under **Oil grade** and **Viscosity** to determine which oil should be used.

## Oil grade

Standard service recommendation	Alternative service recommendation
Transmission oils which comply with the grade requirements for Volvo transmission oil 97305 or engine oils which comply with any of the following grade requirements <ol style="list-style-type: none"> <li>1 API CD, CE or CF (monograde)</li> <li>2 ACEA E1, E2 or E3 (monograde) should be used.</li> </ol>	Transmission oils which comply with the grade requirements for Volvo transmission oil 97307 or 97315 should be used. Please refer to "Viscosity" page 23 to decide which of the two oils should be used.

## Viscosity

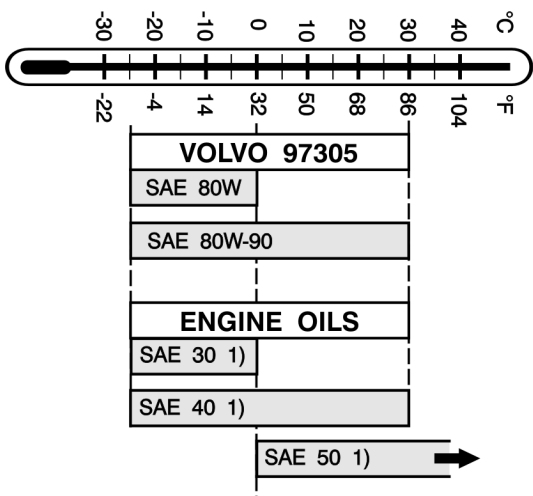
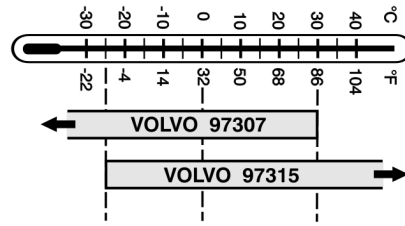
Standard service recommendation	Alternative service recommendation
Viscosity is selected in accordance with the diagram below.  <p>T11008406</p> <p>Temperature values refer to constant air temperatures.</p> <p>1) Applies to engine oils: Note that multigrade oils ARE NOT to be used in manual gearboxes. Use only monograde engine oil SAE 30, SAE 40 or SAE 50.</p> <p>If a TC-MAOH or TC-MAOH2 oil cooler is fitted, SAE 50 engine oil must be used.</p> <p><b>NB!</b> If the temperature is lower than -25°C, use the alternative service recommendation.</p> <p>Gearboxes with TC-MWO, TC-RWO, TC-MWOH or TC-MWOH2 oil coolers can run in ambient temperatures higher than +30°C with SAE30, SAE40 or SAE80W90 engine oils.</p>	Viscosity is selected in accordance with the diagram below.  <p>T11008401</p> <p>Temperature values refer to constant air temperatures.</p> <p>If oil cooler TC-MAOH/-MAOH2 is fitted, transmission oils which comply with the grade requirements for Volvo transmission oil 97315 must be used.</p> <p>Gearboxes with TC-MWO, TC-RWO, TC-MWOH or TC-MWOH2 oil coolers can run in ambient temperatures higher than +30°C with 97307 transmission oil.</p>
For recommendations and more information on oil coolers see VTOS, Volvo Truck Online Service ( <a href="http://productinfo.vtc.volvo.se/vtpi/login/Default.asp">http://productinfo.vtc.volvo.se/vtpi/login/Default.asp</a> )	

- For TRAP-HD and driving in VS and VS+ driving conditions, according to definitions for EOC "Engine

Operating Conditions (EOC)" page 3, oils 97315 or SAE50 are recommended.

- For construction site driving, under very hilly road conditions, equivalent to VS+ driving conditions, the oil should be changed after 2,000 service hours.
- When PTO or split gearboxes are used, the oil should be changed after 2000 service hours.

## Service intervals

### First oil and filter change:

Service category	Interval
Service categories 1 and 3	First oil and filter change after 10,000 km or 4 weeks, whichever occurs first.
Service categories 2 and 4	First oil and filter change after 400,000 km or three years, whichever occurs first.

### Following change intervals as shown in the table below:

Oil grade	Service category		
	G	1 and 3	2 and 4
	Oil and filter change interval (km)		
Volvo Transmission oil 97305 Engine oil SAE30 or 40	120,000/12 months	120,000/12 months	—
Engine oil SAE50	120,000/12 months	120,000/12 months	120,000/12 months
Volvo Transmission oil 97307	180,000/12 months <sup>1</sup>	400,000/36 months	—
Volvo Transmission oil 97315	180,000/12 months <sup>1</sup>	400,000/36 months	400,000/36 months

<sup>1</sup> Note the limitations for this category on page 18.

- For construction site driving, under very hilly road conditions, the oil should be changed after 2,000 hours driving

### Replenishing oil level in gearbox

When the gearbox oil level is too low, it must be topped up. The following then applies:

- If the same oil which already is in the gearbox is used when topping up, there is no limit on how much oil can be filled or how many times the oil level can be topped up in the gearbox.

- If a different approved oil other than the one in the gearbox is used, then no more than one litre in total may be added. This is regardless of how many times the oil level is topped up. If more oil needs to be added, carry out a complete oil change instead.

### Oil and filter changes after a repair on the gearbox

If a component has been repaired, renovated or opened, an extra oil and filter change must be carried out. This oil and filter change should be carried out after 10,000 km or

4 weeks, whichever occurs first, after the component has been repaired, overhauled or opened.

When the extra oil and filter change has been completed, the component's normal service recommendation applies.



## 1b. ZF manufactured manual gearboxes

### Oil change volumes

Gearbox	Oil change volume, approx. litres
T500A	3,5
ST500	10
T700	6

Gearbox	Oil change volume, approx. litres
ST700	9
R800	9,5

### Oil grade

Gearbox	Transmission oil	Engine oil (monograde)
T500A ST500 R800	Volvo transmission oil 97305 API GL-4 (only viscosity quality SAE80W)	API CD, CE, CF or ACEA E1, E2, E3
T700 ST700	ATF Dexron III	

### Viscosity

Viscosity is selected in accordance with the diagram.

Temperature values refer to constant air temperatures.

1) Applies only to gearboxes T700 and ST700.

2) Volvo transmission oil 97305, viscosity grades SAE 85W-140 or SAE 140 is recommended for gearboxes without oil coolers at air temperatures higher than +30° C or for heavy driving or for frequent driving under hilly road conditions.

3) At temperatures below -25° C, Volvo Thermo oil is recommended (part no. 1161904).

4) Applies to engine oils: Note that multigrade oils ARE NOT to be used in manual gearboxes. Only use engine oil SAE 30 or SAE 40.

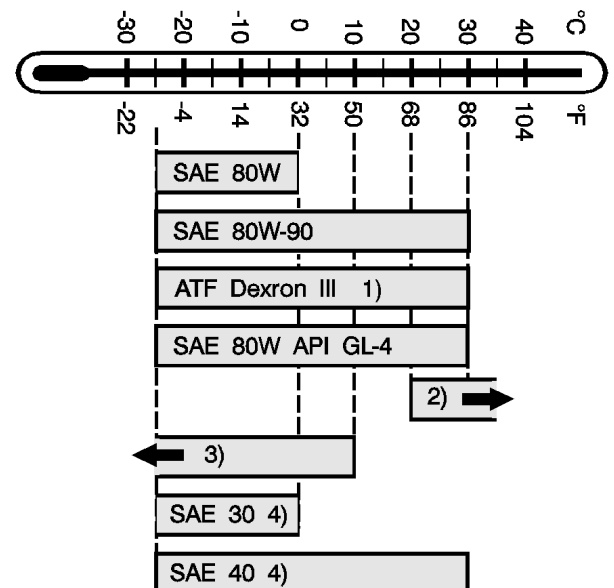

### Service intervals

Gearbox	Service intervals
T500A ST500 T700 ST700	First oil change after 10,000 km or 4 weeks, whichever occurs first. After the first oil change, the oil should be changed every 120,000 km or once a year, whichever occurs first.
R800	Oil change every 120,000 km or once a year, whichever occurs first.

The change interval must be halved for heavy driving or frequent driving under hilly road conditions.

## 1c. Eaton manufactured manual gearboxes

### Oil change volumes

Gearbox	Oil change volume, approx. litres
T600A, T600B, T600C, T700A, T700B, TO800	7,5

### Oil grade

Gearbox	Transmission oil	Engine oil (monograde)
T600A T600B T600C T700A T700B	Volvo transmission oil 97305 API GL-4 (only in viscosity grade SAE 80W) ATF Dexron III	API CD, CE, CF or ACEA E1, E2, E3
TO800	Volvo transmission oil 97305 API GL-4 (only in viscosity grade SAE 80W)	

### Viscosity

Viscosity is selected in accordance with the diagram.

Temperature values refer to constant air temperatures.

1) Volvo transmission oil 97305, viscosity grades SAE 85W/140 or SAE 140. Recommended for gearboxes without oil coolers at air temperatures higher than +30° C, for heavy driving or for frequent driving under hilly road conditions.

2) At temperatures below -25° C, Volvo Thermo oil is recommended (part no. 1161904).

3) Applies to engine oils: Note that multigrade oils ARE NOT to be used in manual gearboxes. Only use engine oil SAE 30 or SAE 40.

4) Applies to gearboxes T600A, T600B, T600C, T700A and T700B.

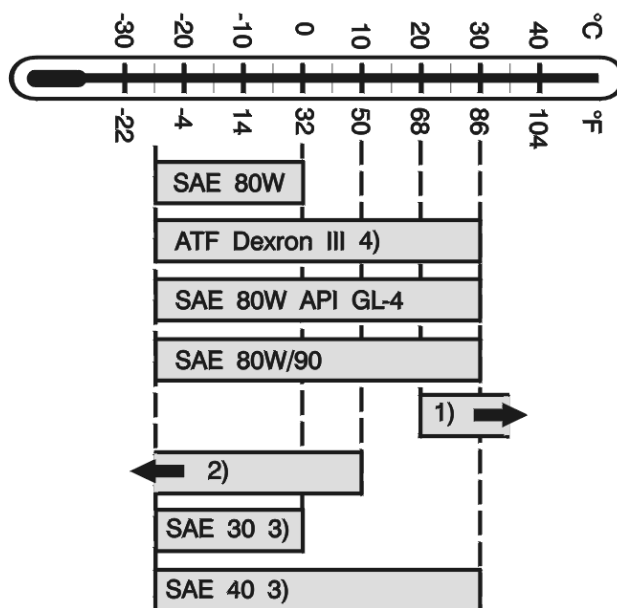

T1007360

### Service intervals

*T600A, T600B, T600C, T700A, T700B, TO800*

- The oil should be changed every 120,000 km or every 12 months, whichever occurs first.
- The change interval must be halved for heavy driving or frequent driving under hilly road conditions.

## 2a. Volvo manufactured automatic transmissions

### Oil change volumes

Gearbox	Oil change volume, approx. litres
PT1650	35
PT1660	35
VT1605PT	35
VT1705PT	35

Gearbox	Oil change volume, approx. litres
VT1706PT	35
VT1906PT	35
VT2206PT	35
VT2506PT	35

### Oil grade

Transmission oils which comply with the grade requirements for both Dexron III and Allison C4 should be used.

### Viscosity

Transmission oils which comply with the grade requirements for both Dexron III and Allison C4

### Service intervals

- First **filter change** after 10,000 km or 4 weeks, whichever occurs first. The oil level must be checked after changing the filter.

**Note:** No oil change should be carried out.

- After the first filter change, the oil and filter should be changed every 90,000 km or every 12 months, whichever occurs first.
- Under some gearbox operating conditions, shorter change intervals may be necessary. Examples of this are:
  - extreme heat
  - a lot of retarder use

- The change interval must be halved for heavy driving or frequent driving under hilly road conditions.
- For construction site driving, under very hilly road conditions, the oil should be changed after 400 hours driving
- All these gearbox types are equipped with a **ventilation filter**, which ensures that air pressure does not build up in the gearbox. The ventilation filter must be kept clean and open, and therefore it must **normally be changed after 24 months**. If the gearbox is being operated in very dusty or dirty conditions, it is necessary to reduce the replacement interval for the ventilation filter.

## 2b. Allison manufactured automatic transmissions

### Oil volumes

Gearbox	Oil change volume, approx. litres
AT545	12
MT643	16
MT653	16
MT654	16
MD3060P air cooled	20

Gearbox	Oil change volume, approx. litres
MD3060P water cooled	18
MD3060PR	28
MD3560P air cooled	20
MD3560P water cooled	18
MD3560PR	28

### Oil grade

Transmission oils which comply with the grade requirements for both Dexron III and Allison C4 should be used.

### Viscosity

Transmission oils which comply with the grade requirements for both Dexron III and Allison C4

## Service intervals

Gearbox	First oil and filter change				Following oil and filter changes			
	Service interval <sup>1</sup>	Changing the inner filter	Changing the external filter	Changing the regulator filter <sup>2</sup>	Service interval	Changing the inner filter	Changing the external filter	Changing the regulator filter <sup>2</sup>
AT545	10,000 km or 4 weeks <sup>3</sup>	No	Yes	<sup>4</sup>	40,000 km or one year <sup>3</sup>	Yes	Yes	<sup>4</sup>
MT643 <sup>5</sup> MT653 <sup>5</sup> MT654	10,000 km or 4 weeks <sup>3</sup>	No	Yes	No	40,000 km or one year <sup>3</sup>	Yes	Yes	Yes
MT643 <sup>6</sup> MT653 <sup>6</sup>	10,000 km or 4 weeks <sup>3</sup>	No	Yes	No	40,000 km or one year <sup>3</sup>	No	Yes	Yes
MD3060P MD3060PR MD3560P MD3560PR	10,000 km or 4 weeks <sup>3</sup>	Yes	<sup>4</sup>	<sup>4</sup>	40,000 km or 18 months <sup>3</sup>	Yes	<sup>4</sup>	<sup>4</sup>

<sup>1</sup> During warranty service.

<sup>2</sup> The filter is in the gearbox rear end.

<sup>3</sup> Whichever occurs first.

<sup>4</sup> The gearbox does not have this filter.

<sup>5</sup> MT643 with serial numbers lower than 2410547098 and MT653 with serial numbers lower than 2410545820.

<sup>6</sup> MT643 with serial numbers later than 2410547098, MT653 with serial numbers later than 2410545820 or MT643 or MT653 with the letters "AA" on the type plate.

- Service intervals for these gearboxes apply to normal operating conditions. Where operating conditions are hard, shorter change intervals may be necessary. Examples of this are:
  - extreme heat
  - a lot of retarder use
- The change interval must be halved for heavy driving or frequent driving under hilly road conditions.
- All these gearbox types are equipped with a **ventilation filter**, which ensures that air pressure does not build up in the gearbox. The ventilation filter must be kept clean and open. **Levels of dust and dirt determines how often** the ventilation filter must be cleaned.

## Rear axle

Because of the differences between different rear axle manufactures **oil recommendations**, these recommendations are sub-divided as follows:

“1a. Heavy rear axles” page 29

“1b. Light rear axles.” page 32

“1c. Other rear axles” page 33

### 1a. Heavy rear axles

Rear axle	Approx. change volume in litres		
	Final drive	Every hub	Total
RAEV80	12		12
RAEV85	12		12
RAEV90	11		11
RAEV91 Leaf springs	11		11
RAEV91 Air suspension	9,5		9,5
RS1344SV	18,5		18,5
RSS1344B	17,5		17,5
RS1356SV Leaf springs	8,5		8,5
RS1356SV Air suspension	9		9
RAN281	27	3	33
RAN371	26	3	32
RAN372	28	3	34
RAN471	26	3	32
RAN472	28	3	34
RS1352HV <sup>1</sup>	19	1,5	22
RS1352HV Leaf springs	20	3	26
RS1352HV Air suspension	16	3	22
RS1365HV	22	3	28
RS1370HV <sup>1</sup>	19	1,5	22
RS1370HV Leaf springs	20	3	26
RS1370HV Air suspension	16	3	22
CTEV87 (front axle) Leaf springs	20		20
CTEV87 (rear axle) Leaf springs	9		9
CTEV87 (front axle) Air suspension	16		16
CTEV87 (rear axle) Air suspension	7,5		7,5
CTN372 (front axle)	26,5	3	32,5

Rear axle	Approx. change volume in litres		
	Final drive	Every hub	Total
CTN372 (rear axle)	23,5	3	29,5
CTN372, BGT32TR (front axle)	22	3	28
CTN372, BGT32TR (rear axle)	20	3	26
CTN472 (front axle)	28	3	34
CTN472 (rear axle)	25	3	31
RT2610HV (front axle) Leaf springs	23	3	30
RT2610HV (rear axle) Leaf springs	19	3	26
RT2610HV (front axle) Air suspension	23	3	29
RT2610HV (rear axle) Air suspension	19	3	25
RT3210HV (front axle) <sup>1</sup>	22,5	1,5	25,5
RT3210HV (front axle) Leaf springs	22,5	3	28
RT3210HV (rear axle)	18,5	1,5	21,5
RT3210HV (rear axle) Leaf springs	18,5	3	24
RTH2610B (front axle) Leaf springs	23	3	30
RTH2610B (rear axle) Leaf springs	19	3	26
RTS2370A (front axle)	20		20
RTS2370A (rear axle)	14		14

<sup>1</sup> The oil volume is 1.5 litres only for hub reduction covers with part numbers 1524851 or 1524852. This marking can be seen on the hub reduction covers.

On vehicles with single gears the oil is filled to the edge of level hole.

On vehicles with hub reduction, the hub is first filled with oil in accordance with the table above. The differential carrier is then filled with oil up to the edge of the level hole.

For a number of reasons not all rear axles can have the same service recommendations. They have therefore been divided up into different service categories.

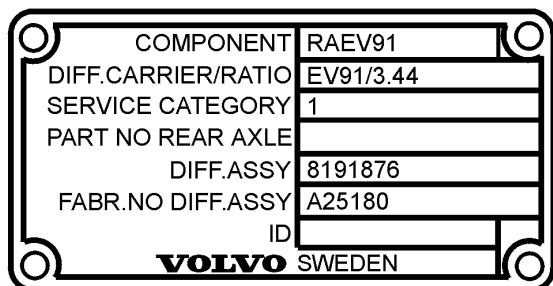

T1006943

The service categories, designated by a number or a letter, are indicated on the **rating plate** located on the rear axle. The categories are G, 1 and 2.

**Note:** If the rear axle **does not have** a service category marked on the **rating plate**, it belongs to **Service category G**.

Two different service recommendations can be applied to rear axles:

- **Standard service recommendation**
- **Alternative service recommendation**

The alternative service recommendation provides longer service intervals than standard service recommendation. The alternative service recommendation requires the use of special oils. Limits in the table must however be observed.

Customers can always select the service recommendation they prefer after taking into consideration the relevant restrictions described in the following table.

Service-category	Restrictions when using alternative service recommendation
G	The alternative service recommendation must not be used for rear axle <b>RAN281</b> .

The standard service recommendation and alternative service recommendation both consist of three parts. The three parts are **oil grade**, **viscosity** and **service intervals**. These are found in the same order on the following pages.

The following procedure can be very useful when deciding which oil to use.

- 1 Find out which service category the component belongs to.
- 2 Use the information in the table below **Service intervals** and determine which service recommendation should be used.
- 3 Use the information under **Oil grade** and **Viscosity** to determine which oil should be used.

## Oil grade

Standard service recommendation	Alternative service recommendation
Transmission oils which comply with the grade requirements for API GL-5 shall be used.	Transmission oils complying with the requirements for Volvo transmission oil 97312 shall be used.

## Viscosity

Standard service recommendation	Alternative service recommendation
<p>Viscosity is selected in accordance with the diagram below.</p> <p>T1008327</p> <p>Temperature values refer to constant air temperatures.            1) For heavy driving or for frequent driving under hilly road conditions SAE 80W-140, SAE 85W-140 or SAE 140 is recommended (instead of normal SAE 90).            2) SAE 90 is not to be used in RAN281 rear axles.</p> <p><b>Note:</b> SAE 80W/90 must not be used.</p>	<p>Transmission oils complying with the requirements for Volvo transmission oil 97312 shall be used. Oil of the correct viscosity will then be obtained automatically. These oils must be used irrespective of ambient temperatures.</p>

## Service intervals

### First oil change:

Service category	Interval
Service categories 1 and G	First oil change after 10,000 km or 4 weeks, whichever occurs first.
Service category 2	First oil and filter change after 400,000 km or three years, whichever occurs first.

### Following change intervals as shown in the table below:

Oil grade	Service category	
	G	1 and 2
	Oil change interval (km)	
API GL-5	120,000/12 months	120,000/12 months
Volvo Transmission oil 97312	180,000/12 months <sup>1</sup>	400,000/36 months

<sup>1</sup> Note: This recommendation does not apply to RAN281.

- For construction site driving, under very hilly road conditions, the oil should be changed after 2,000 hours driving

**Replenishing oil level in rear axle**

When a rear axle oil level is too low, it must be topped up. The following then applies:

- If the same oil as is in the rear axle is used when topping up, there is no limit to how much oil can be filled or how many times the oil level can be topped up in the rear axle.

**Oil change after repairing the rear axle**

If a component has been repaired, renovated or opened, an extra oil change must be carried out. This oil change should be carried out after 10,000 km or 4 weeks,

- If a different approved oil other than the one in the rear axle is used, then no more than one litre in total may be added. This is regardless of how many times the oil level is topped up. If more oil needs to be added, carry out a complete oil change instead.

whichever occurs first, after the component has been repaired, overhauled or opened.

When the extra oil change has been completed, the component's normal service recommendation applies.

**1b. Light rear axles.**

**Oil change volumes**

Rear axle	Oil change volume, approx. litres
RAEV76	10
RAEV78	10
RS0618	12 (not including hub)
RS0818	12 (not including hub)

Rear axle	Oil change volume, approx. litres
RS0818SV	6
RS1026SV	10
RS1332SV	18,5
RSS1032A	18,5

**Oil grade**

Transmission oil API GL-5.

**Viscosity**

Viscosity is selected in accordance with the diagram.

Temperature values refer to constant air temperatures.

1) For heavy driving or for frequent driving under hilly road conditions SAE 140, SAE 85W/140 or SAE 85W/140 is recommended (instead of normal SAE 90).

**Note:** SAE 80W/90 must not be used.

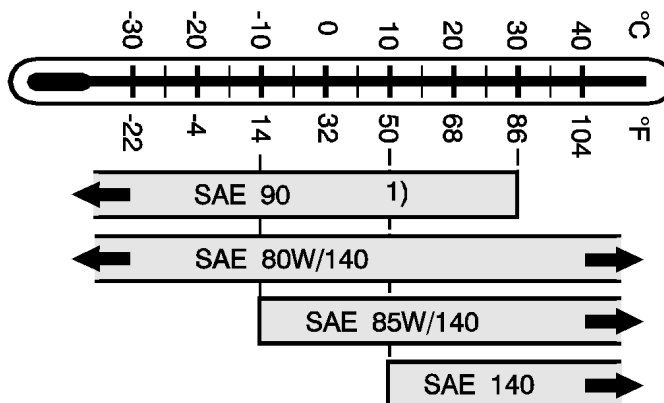



## Service intervals

Rear axle	Service interval
RAEV76	<ul style="list-style-type: none"> <li>• First oil change after 10,000 km or 4 weeks, whichever occurs first.</li> </ul>
RAEV78	
RS0618	
RS0818	<ul style="list-style-type: none"> <li>• After the first oil change, the oil should be changed every 120,000 km or once a year, whichever occurs first.</li> <li>• For heavy driving or for frequent driving under hilly road conditions, the change interval is halved.</li> </ul>
RS0818SV	
RS1026SV	<ul style="list-style-type: none"> <li>• Oil change every 120,000 km or once a year, whichever occurs first.</li> <li>• For heavy driving or for frequent driving under hilly road conditions, the change interval is halved.</li> </ul>
RS1332SV	
RSS1032A	

## 1c. Other rear axles

### Oil change volumes

Rear axle	Oil change volume, approx. litres
RSS1357A	22

RTS2673A, first axle	19
RTS2673A, second axle	18

### Oil grade

Transmission oil API GL-5

### Viscosity

Viscosity SAE 85W/140 should be used.

## Service intervals

Rear axle	Service interval
RSS1357A RTS2673A	<ul style="list-style-type: none"> <li>• First oil change after 10,000 km or 4 weeks, whichever occurs first.</li> <li>• After the first oil change, the oil should be changed every 120,000 km or once a year, whichever occurs first</li> <li>• The change interval must be halved for heavy driving or frequent driving under hilly road conditions.</li> </ul>

## Driving front axle

### Oil change volumes

Driving front axle	Oil change volume, approx. litres
FAN R8	9,5
FAN R9	11,5

Driving front axle	Oil change volume, approx. litres
FS0910HZ	11,5
Please note that hub change volumes are not included in these figures. Each hub's change volume is around 1.5 litres.	

### Oil grade

Transmission oil API GL-5.

### Viscosity

Viscosity is selected in accordance with the diagram.

Temperature values refer to constant air temperatures.

1) For heavy driving or for frequent driving under hilly road conditions SAE 80W140, SAE 85W140 or SAE 140 is recommended (instead of normal SAE 90).

**Note:** SAE 80W/90 must not be used.

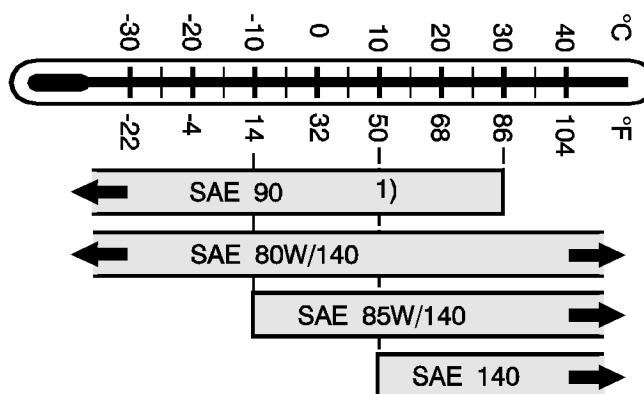

T1006287

### Service intervals

- First oil change after 10,000 km or 4 weeks, whichever occurs first.

- After the first oil change, the oil should be changed every 120,000 km or every 12 months, whichever occurs first.

### Replenishing oil level in a driving front axle

When a driving front axle oil level is too low, it must be topped up. The following then applies:

- If the same oil as is in the driving front axle is used when topping up, there is no limit on how much oil can be filled or how many times the oil level can be topped up in the driving front axle.

- If a different approved oil other than the one in the driving front axle is used for topping up, then no more than one litre may be used. This is regardless of how many times the oil level is topped up. If more oil needs to be added, carry out a complete oil change instead.

**Oil change after repair of driving front axle**

If a component has been repaired, renovated or opened, an extra oil change must be carried out. This oil change should be carried out after 10,000 km or 4 weeks,

whichever occurs first, after the component has been repaired, overhauled or opened.

When the extra oil change has been completed, the component's normal service recommendation applies.

**Transfer case**

**Oil change volumes**

Transfer case	Oil change volume, approx. litres
FD7	5,5
VT2501TB	5,5

The oil level in transfer gearboxes with transparent level plugs should lie between the centre of the level plug and the max mark.

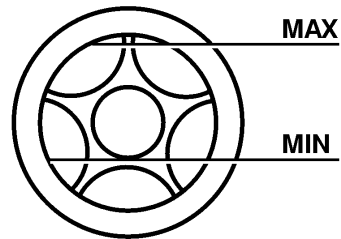

T1007661

On transfer cases without transparent level plugs, the oil level should be up to the edge of the level hole.

**Oil grade**

Standard service recommendation	Alternative service recommendation
<p>Transmission oils which comply with the grade requirements for Volvo transmission oil 97305 or engine oils which comply with any of the following grade requirements</p> <p>1 API CD, CE or CF (monograde)</p> <p>2 ACEA E1, E2 or E3 (monograde) should be used.</p>	<p>Transmission oils complying with the requirements for Volvo transmission oil 97307 shall be used.</p>

## Viscosity

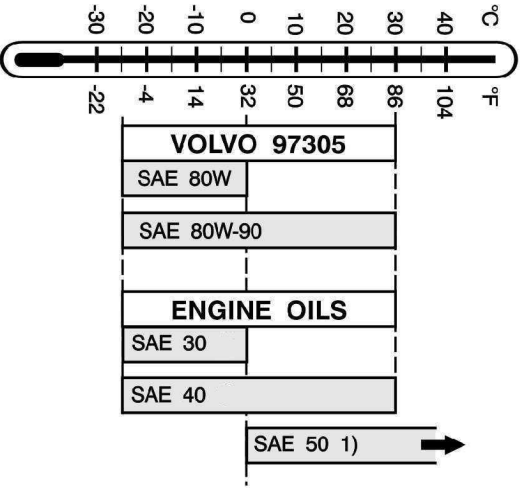
Standard service recommendation	Alternative service recommendation
<p>Viscosity is selected in accordance with the diagram below.</p>  <p>T1008535</p> <p>1) For components which are operated at stable ambient temperatures higher than +30°C.          Applies to engine oils: note that multigrade oils <b>MUST NOT</b> be used.  <b>Note!</b> If the temperature is lower than -25°C, use the alternative service recommendation.</p>	<p>Transmission oils which comply with the quality requirements for Volvo transmission oil 97307 should be used. Oil of the correct viscosity will then be obtained. For ambient temperatures above 30°C, transmission fluids which comply with the quality requirements for Volvo transmission fluid 97315 should be used.</p>

## Service intervals

Standard service recommendation	Alternative service recommendation
<ul style="list-style-type: none"> <li>First oil change after 10,000 km or 4 weeks, whichever occurs first.</li> <li>After the first oil change, the oil should be changed every 120,000 km or once a year, whichever occurs first.</li> </ul>	<ul style="list-style-type: none"> <li>First oil change after 10,000 km or 4 weeks, whichever occurs first.</li> <li>After the first oil change, the oil should be changed every 180,000 km or once a year, whichever occurs first.</li> </ul>

### Replenishing oil level in transfer gearbox

When a transfer gearbox oil level is too low, it must be topped up. The following then applies:

- If the same oil as is in the transfer gearbox is used for topping up, then there is no limit to how much oil can be filled or how many times the transfer gearbox can be topped up.

### Oil change after repair of the transfer case

If a component has been repaired, renovated or opened, an extra oil change must be carried out. This oil change should be carried out after 10,000 km or 4 weeks,

- If a different approved oil other than the one in the transfer gearbox is used, then no more than a total of 0.5 litre may be added. This is regardless of how many times the oil level is topped up. If more oil needs to be added, carry out a complete oil change instead.

whichever occurs first, of the component being repaired, overhauled or opened.

When the extra oil change has been completed, the component's normal service recommendation applies.

## Power take off (flywheel fitted)

### Oil change volumes

Power take off	Approx. change volume in litres
KOBLAM	5
KOBKLO	5
PTOF-DIF SAE 1	5
PTOF-DIH SAE 1	5
PTOF-DIF SAE 2	4,5
PTOF-DIH SAE 2	4,5

If an oil cooler is fitted, extra oil will be required as shown in the table below:

Component	Approximate extra oil volume in litres
COOL-PTO	1

### Oil grade

#### Transmission oil:

Volvo transmission oil 97305.

#### Engine oil:

API CD, CE, CF or ACEA E1, E2, E3.

### Viscosity

Standard service recommendation	Alternative service recommendation
<p>Viscosity is selected in accordance with the diagram below.</p> <p>The diagram shows a thermometer with two scales: Celsius (°C) on top and Fahrenheit (°F) on the bottom. Below the thermometer, horizontal bars indicate the recommended oil grades for different temperature ranges. For Volvo 97305, the range is from -30°C to 40°C. For SAE 80W, the range is from -30°C to 0°C. For SAE 80W-90, the range is from -22°C to 32°C. For SAE 30, the range is from 0°C to 32°C. For SAE 40, the range is from 0°C to 50°C. For SAE 50 1), the range is from 32°C to 86°C, with an arrow pointing to the right, indicating it is used for temperatures above 86°C.</p>	—
<p>T1008535</p> <p>1) For components without oil coolers which are operated at stable ambient temperatures higher than +30°C. Applies to engine oils: note that multigrade oils MUST NOT be used. Components with oil coolers can be operated in ambient temperatures higher than +30°C.</p>	

### Service intervals

- First oil and filter change after 10,000 km or 4 weeks, whichever occurs first.
- After the first oil and filter change, the oil and filter should be changed every 120,000 km or every 12 months, whichever occurs first.

## Hydraulic retarder

### Oil change volumes

Hydraulic retarder	Oil change volume, approx. litres
<b>Voith FH</b>	6,0 ± 0,1
<b>RET-TH</b>	
Only oil change	5,4 ± 0,1
Dry retarder and/ or heat exchanger replacement	6,1 ± 0,1

The type of retarder must be known if a service is to be carried out in a correct way. The information can be obtained by reading the retarder's rating plate, see figure.

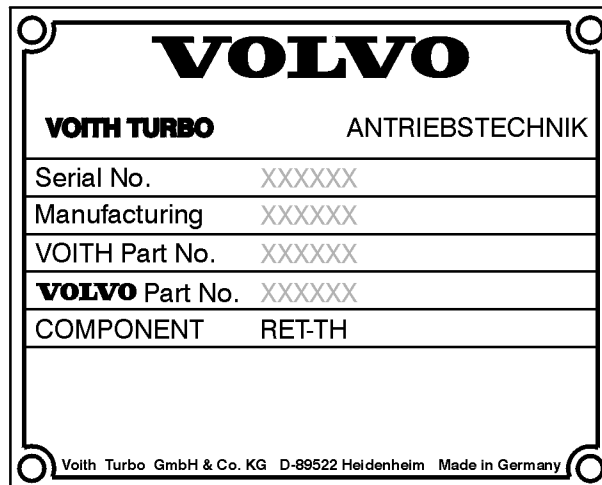

T5011336

**Note:** The name of the retarder is not marked on the type plate in some cases. In these cases, the retarder is a Voith FH.

### Oil grade

Select an engine oil which complies with one of the following grade requirements:

- 1 API CD, CE or CF
- 2 ACEA E1, E2 or E3.

### Viscosity

Use an **engine oil** with any of the following viscosities, independent of outdoor temperatures:

Mineral oil	Synthetic or semi synthetic oil
SAE 10W	SAE 0W-40
SAE 20W	SAE 5W-30
SAE 30	SAE 5W-40
	SAE 5W-50
	SAE 10W-30
	SAE 10W-40

## Service intervals

Retarder type	When using mineral oil	When using synthetic oil
Voith FH	<ul style="list-style-type: none"> <li>First oil change after 90,000 km or 2 years, whichever occurs first.</li> <li>After the first oil change, the oil should be changed every 90,000 km or every second year, whichever occurs first.</li> </ul>	<ul style="list-style-type: none"> <li>First oil change after 90,000 km or 2 years, whichever occurs first.</li> <li>After the first oil change, the oil should be changed every 135,000 km or every second year, whichever occurs first.</li> </ul>
RET-TH	<ul style="list-style-type: none"> <li>First oil change after 120,000 km or 2 years, whichever occurs first.</li> <li>After the first oil change, the oil should be changed every 120,000 km or every second year, whichever occurs first.</li> </ul>	<ul style="list-style-type: none"> <li>First oil change after 120,000 km or 2 years, whichever occurs first.</li> <li>After the first oil change, the oil should be changed every 135,000 km or every second year, whichever occurs first.</li> </ul>

When the retarder is operated frequently under specific conditions, oil change intervals should be halved. An example of such conditions are:

- use in areas with high ambient temperatures, such as in Saudi Arabia
- timber trucks and construction site vehicles
- high gross weight and low engine power (less than 8 hp/ton)

- a lot of driving under extremely hilly road conditions
- extremely short distances with very steep downgrades.

In individual cases, where the retarder is used more than 10 % of the vehicle's mileage, the service interval must be reduced. This also applies to factors not mentioned here, which can affect the ageing of the oil.

The service interval for repaired or opened components are the same as for new components.

## Propeller shaft lubrication

There are both lubricated and non-lubricated (no service required) propeller shafts. Lubricated propeller shafts are equipped with support bearings and/or universal joints fitted with grease nipples. Propeller shafts which are completely non-service required do not have lubricating nipples, neither on universal joints nor on support bearings.

Two different service recommendations can be applied to lubricated propeller shafts. (Does not apply to FLC.)

- Standard service recommendation
- Alternative service recommendation

The customer can always choose the service recommendation preferred. Both service recommendations are subdivided into **grease quality** and **service intervals**.

- Use the information in the table below **Service intervals** and determine which service recommendation should be used.
- Use the information under **Grease quality** to determine the grease to be used.
- Return to the information under **Service intervals** and find the service interval.

## Lubricated components (with grease nipples)

### Grease quality

#### Standard service recommendation

Requirements for lubricating grease are as follows:

- High grade wheel bearing grease should be used.
- The grease should be mineral oil based
- The grease should be lithium or lithium complex type.
- The grease should contain EP and anti-rust additives.
- The grease must have a consistency equivalent to NLGI no. 2.

- The grease should not contain any solid lubricants, such as graphite, copper or molybdenum sulphide.
- The grease must be intended for use in working temperatures of at least 80<sup>o</sup> C and be able to withstand 120<sup>o</sup> C for short periods.

Where in doubt: use grease with Volvo Part. no. 1161251-2.

#### Alternative service recommendation

Requirements for lubricating grease are as follows:

- Volvo part no. 1161973-1

## Service intervals

Vehicles	Standard service recommendation	Alternative service recommendation
FLC	25,000 km/6 mth <sup>1</sup>	-
Other		
Distribution and long distance driving	25,000 km/3 mth <sup>1</sup>	30,000 km/3 mth <sup>1</sup>
Timber trucks and construction sites	10,000 km/3 mth <sup>1</sup>	15,000 km/3 mth <sup>1</sup>
Heavy construction and off-road	2,500 km/3 mth <sup>1</sup>	4,000 km/3 mth <sup>1</sup>

<sup>1</sup> Whichever occurs first

## Opened and repaired components

After a component has been repaired or opened it needs to be re lubricated. Use grease listed in the table below.

### Grease quality

<b>Universal joint (lubricated) with lubricating nipple</b>	See the Grease grade table under the section Lubricated components (with lubricating nipple)
<b>Universal joint (non-lubricated) without lubricating nipple</b>	Grease requirements: Volvo part no. 3091917-9
<b>Support bearing Sliding splines</b>	See the Grease grade table under the section Lubricated components (with lubricating nipple)

The service intervals for repaired and opened components are the same as for new components.



## Power steering, Steerable pusher axle, Bogie lift, Hub, Cab tilt pump

	Oil and grease quality	Oil volume	Oil and grease change	Filter change
Power steering	ATF oil type Dexron III	approx. 4.5 litre	Only when repaired.	Once a year.
FLC, FL6				
PSS-SING				
PSS-DUAL		approx. 9.0 litre		
Control system, hydraulic steered pusher axle and hydraulic steered trailing axle	ATF oil type Dexron III	approx. 5.0 litre	Only when repaired.	
Bogie lift	Hydraulic fluid BLV or equivalent complying with Standard MIL-H-5606F	5.5 litres	Once a year.	For trucks manufactured up to 1990. Once a year.
Wheel hub, oil lubricated (single mounted wheels)	Engine oil SAE 30	0.3 litres per wheel	Only when working with the hub or if contaminants have entered the wheel hub.	
Cab tilt pump	Hydraulic oil BLV		Only when repaired.	
Greased wheel hub	Lithium based grease of consistency NLGI No. 2 or 2.5		Only after working on the hub or if impurities have entered the wheel hub.	
Greased wheel hub FL6, FLC	Lithium complex based grease of consistency NLGI no. 2.5			

## Brakes

	Grade	Change interval
Spring brake cylinder diaphragm (hydraulic disc brakes) FLC, FL6		Change interval every 12 months.

Desiccant for the air drier	
AIRDRY-E	Change interval was every 24 months or when the symbol on the driver's display lights. When this function is not activated the change interval is every 12 months.
Other	Change interval was every 12 months or max 200,000 km, whichever occurred first.

## Chassis lubrication

Lubrication points, see the lubrication chart for the relevant vehicle model.

"Grease quality" page 42

"FLC, FL6 CHID B265000-, other vehicles" page 42

"FM, FH" page 42

"Fifth wheel" page 43

"Central lubrication system" page 43

## Grease quality

Lithium based grease with EP additives and of consistency NLGI no. 2.

### FLC, FL6 CHID B265000-, other vehicles

Vehicles	Maximum time interval	Maximum mileage interval
FLC	6 months	25,000 km
FL6 Chassis number: B265000 -	6 months	40,000 km
FL equipped with A/B/T - ride	Please refer to table "FM, FH" page 42.	
Other vehicles	3 months	-

## FM, FH

For definition of Transport cycle, see "Transport cycle" page 3.

Each definition has an abbreviation that is used in the table below.

### Road Condition (RC), definition

#### Smooth (S)



T1008231

#### Rough (R)



T1008232

#### Very rough (VR)



T1008233

*Lubricate intervals FH, FM*

Transport cycle	Long distance driving		Distribution		Construction sites <sup>1</sup>			
	RC	S	R	S	R	S/R	VR	
	Km / months <sup>2</sup>		Km / months <sup>2</sup>		Km / months <sup>2</sup>		Km / months <sup>2</sup>	
Chassis lubrication	90000 <sup>3/6</sup>		60000/4		60000/4		30000/3	
A-/B-/T-ride <sup>4 5</sup>	40000/3		20000/1		40000/3		20000/1	
	4500/0,5		1000 <sup>6</sup> /0,25					

<sup>1</sup> Includes timber trucks, tippers, dumpers, load exchangers, concrete mixers, waste compressors and special vehicles.

<sup>2</sup> Whichever occurs first

<sup>3</sup> Within Europe and if gross weight is maximum 36 tons, the interval can be increased to 100,000 km

<sup>4</sup> B-ride is without lubrication on vehicles built from week 43 in 2003 onwards. T-ride is without lubrication on vehicles built from week 11 in 2005 onwards.

<sup>5</sup> As follows: A-ride: suspension, bogie bearing and bogie lift, B-ride and T-ride - bogie bearing.

<sup>6</sup> Under some conditions, more frequent lubrication may be required

**Fifth wheel**

For the fifth wheel, a lithium based grease with consistency NLGI 2 is used, i.e. Volvo grease 2 EP with part number 1161960.

**Central lubrication system**

**Grease quality**

Part	Part number	Note
Volvo Grease 00 CS	3093926	
Volvo Grease 00 CSBD	3093927	Bio-degradable

**Other approved grease grades**

Supplier	Grease
ARAL AG	Fliessfett AN 0
BP Oil Deutschland GmbH	BP Energ grease ZS 0
DEA Mineralöl AG	DEALITH EP 0
Zeller+Gmelin GmbH & Co	Divinol L 0
ARAL AG	Fliessfett N
Autol-Werke GmbH	Autol Getriebefliessfett ZSA
AVIA Mineralöl AG	AVIALITH 000 EP
BP Oil Deutschland GmbH	Energ grease ZS 00
Calypsol	SF7-042
Castrol Ltd., England	Castrol CLS Grease
DEA	Dealit EP 00
Deutsche Shell AG	Shell Retinax CS
ELF	MULTI BT 000
Esso	Grease TCL 435
FINA	MARSON ZS - G 0116
Fuchs Mineralölwerke GmbH	Renolit LZR 000
Georg Oest Mineralölwerke	Oest Spezialfett LT 000 EP
Kompressol-Öl Verkaufs GmbH	Kompressol CZ 8332/N

Supplier	Grease
KRAFFT	KEC-Grease
Mobil Schmoerstoff GmbH	Mobilgrease EAL 003
Mobil Schmoerstoff GmbH	Chassis Grease LBZ
MOL	Carrier Liton-00
ÖMV - GmbH	ÖMV-Signum EP Z
Optimol	Olit 00
Pluto	Plutoleum SHM 000
Reiner Chemische Fabrik GmbH	Gearmaster ZSA
RHENUS Wilhelm Reiners GmbH & Co.	Rhenus Norlith FZS 000
	Rhenus Norlith BZS 0 <sup>1</sup>
	Rhenus Norlith BZS 000 <sup>1</sup>
Siebert GmbH	Fliessfett EP7028
Texaco	Multifak 6833 EP 00
Veedol Int. Ltd., England	Veedol GFG
Wintershall AG	Wiolub LFK 00
Zeller+Gmelin GmbH & Co	Divinol Fett Central 00

<sup>1</sup> Bio-degradable

**Top up interval**

The top up interval for the central lubrication system is every six months or when the level falls to the minimum level on the container.

The volume is 2.7 kg for tractor units and 6 kg for other units.

**Cab**

**Cab filter**

Model	Change interval
FL/ FM/ FH/ NH	12 months

**Cab lubrication**

The cab is lubricated when a basic service or annual service is carried out, or when required.

## Volvo oils and fluids

### Engine oils

Oils which comply with VDS-3		
Viscosity	Part no.	Volume in litres
SAE 15W/40	85102465	208
	85102464	20
	85102463	5
SAE 10W/40 semi synthetic	85102469	208
	85102468	20
	85102467	5
Oils which comply with VDS-2		
Viscosity	Part no.	Volume in litres
SAE 15W/40	1161976	208
	1161975	20
	1161974	5
SAE 10W/30	85108287	208
SAE 5W/30 synthetic	85102470	208
Oils which comply with VDS		
Viscosity	Part no.	Volume in litres
SAE 15W/40	1161972	208
	1161971	20
	1161970	5
Oil for gas engine		
Viscosity	Part no.	Volume in litres
SAE 15W/40 synthetic	85104226	208
Oils for front wheel hub		
Viscosity	Part no.	Volume in litres
SAE 30	1161944	20
	1161943	5

### Special oil

Volvo special oil for the mechanical compressor on D6A250	Part no.	Volume in ml
	85108974	250

## Transmission oils

Volvo transmission oil 97305		
Viscosity	Part no.	Volume in litres
SAE 80W/90	1161280	208
	1161933	20
	1161932	5
Volvo thermo oil		
	Part no.	Volume in litres
	1161904	20
Volvo transmission oil 97307		
	Part no.	Volume in litres
	85108171	208
	85108170	20
Volvo transmission oil 97315.		
	Part no.	Volume in litres
	85107476	20
Transmission oil API GL-5		
Viscosity	Part no.	Volume in litres
SAE 85W/140	1161279	208
	1161937	20
	1161936	5
Volvo transmission oil 97312		
	Part no.	Volume in litres
	1161949	208
	1161985	20
Dexron III, Allison C4	Part no.	Volume in litres
	1161997	208
	1161996	20
	1161995	5
	1161521	1

## Hydraulic oils

Volvo hydraulic oil	Part no.	Volume in litres
	1161940	208
	1161939	20
Volvo hydraulic oil BLV	1161942	208
	1161938	4
	1161935	1
Hydraulic oil, bio-degradable	3093938	20

## Coolants

Volvo coolants	Part no.	Volume in litres
Volvo Coolant	1089240	210
Volvo Coolant <sup>1</sup>	1161989	210
Volvo Coolant	1089238	5
Volvo Coolant	1089237	1
Volvo Coolant VCS	85108901	210
Volvo Coolant VCS	85108900	5
Ready mixed coolant for -25°C		
Volvo Coolant	1161990	210
Volvo Coolant	1161994	5
Volvo Coolant VCS	85108914	210
Volvo Coolant VCS	85108913	5

<sup>1</sup> Only for the French market

## Brake fluid

Brake fluid in accordance with DOT3	Part no.	Volume in litres
	85104143	1
Brake fluid in accordance with DOT4	Part no.	Volume in litres
	1161967	0,25
	1161968	1
	1381075	25

## Grease

Grease	Part no.	Amount
Wheel bearing grease, Volvo grease Lix 2.5 EP Lithium complex NLGI 2.5	1161241	80 g
	1161251	420 ml
	1161981	1 kg
	1161982	18 kg
	1161983	50 kg
	1161984	180 kg
Chassis grease Volvo grease 2 EP Lithium NLGI 2	1161960	420 ml
	1161961	18 kg
	1161315	50 kg
	1161962	180 kg

## Grease for central lubrication system

Grease	Part no.	Amount
Volvo grease 00 CS NLGI 00	3093926	18 kg
Volvo grease 00 CSBD NLGI 00, bio-degradable	3093927	18 kg